

Features

- Full Power at Wide Output Current Range (Constant Power)
- Adjustable Output Current (AOC) with Programmability
- Isolated 1-10V/10V PWM/3-Timer-Modes Dimmable
- Output Lumen Compensation
- End-of-Life Indicator
- Input Surge Protection: DM 6kV, CM 10kV
- All-Around Protection: OVP, SCP, OTP
- IP66 / IP67 and UL Dry / Damp / Wet Location
- TYPE HL, for use in a Class I, Division 2 hazardous (Classified) location
- 5 Years Warranty



Description

The ESM-240SxxxDx series is a 240W, constant-current, programmable and IP66/IP67 rated LED driver that operates from 249-528Vac input with excellent power factor. It is created for many lighting applications including high bay, high mast and roadway, etc. The high efficiency of these drivers and compact metal case enables them to run cooler, significantly improving reliability and extending product life. To ensure trouble-free operation, protection is provided against input surge, output over voltage, short circuit, and over temperature.

Models

Adjustable Output Current Range	Full-Power Current Range(1)	Default Output Current	Input Voltage Range(2)	Output Voltage Range	Max. Output Power	Typical Efficiency (3)	Typical Power Factor		Model Number (5)
							277Vac	480Vac	
70-1050mA	700-1050mA	700 mA	249~528 Vac/ 352~500 Vdc	115~343Vdc	240 W	94.5%	0.99	0.95	ESM-240S105Dx
105-1500mA	1050-1500mA	1050 mA	249~528 Vac/ 352~500 Vdc	80~229 Vdc	240 W	94.0%	0.99	0.95	ESM-240S150Dx
215-3500mA	2150-3500mA	2150 mA	249~528 Vac/ 352~500 Vdc	35~111 Vdc	240 W	94.0%	0.99	0.95	ESM-240S350Dx ⁽⁴⁾
420-6700mA	4200-6700mA	4900 mA	249~528 Vac/ 352~500 Vdc	18 ~ 57 Vdc	240 W	93.0%	0.99	0.95	ESM-240S670Dx ⁽⁴⁾

Notes: (1) Output current range with constant power at 240W

(2) Certified input voltage range: 277-480Vac.

(3) Measured at 100%load and 480Vac input (see below "General Specifications" for details).

(4) SELV output.

(5) x = G are UL Recognized and ENEC, etc. models; x = T are UL Class P models.



Singel 3 | B-2550 Kontich | Belgium | Tel. +32 (0)3 458 30 33

info@alcom.be | www.alcom.be

Rivium 1e straat 52 | 2909 LE Capelle aan den IJssel | The Netherlands

Tel. +31 (0)10 288 25 00 | info@alcom.nl | www.alcom.nl

I-V Operation Area

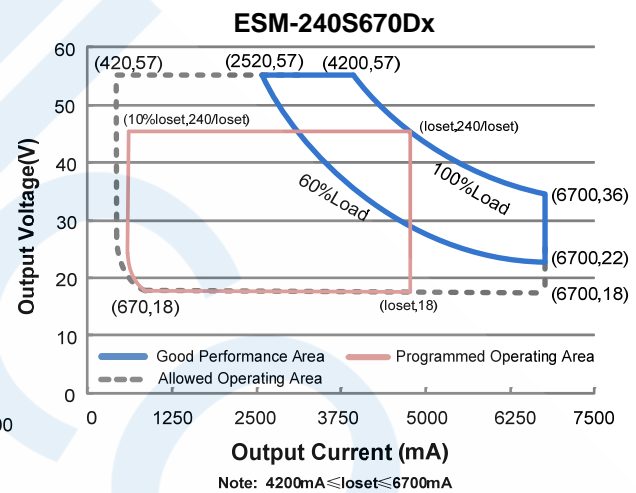
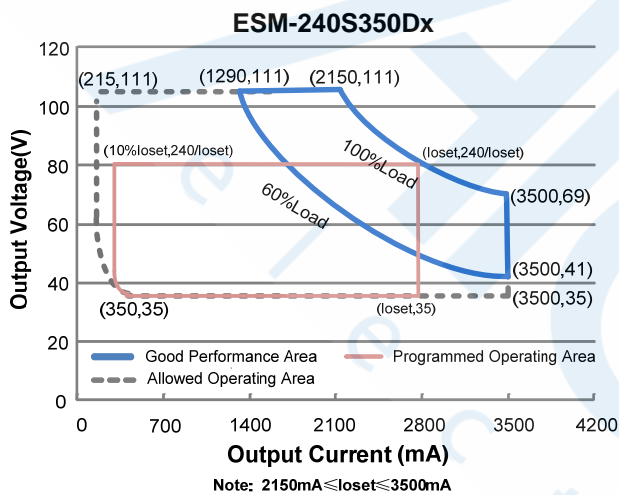
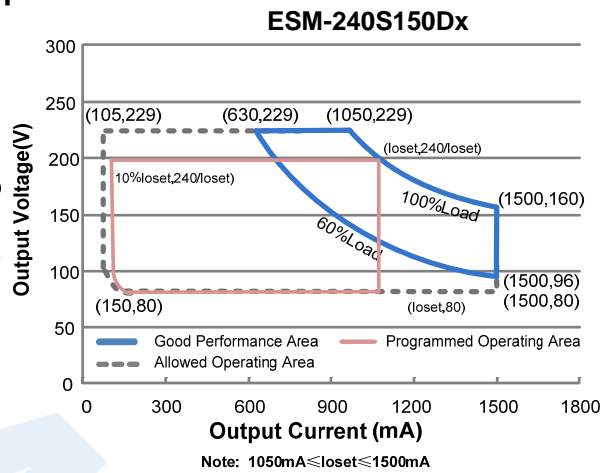
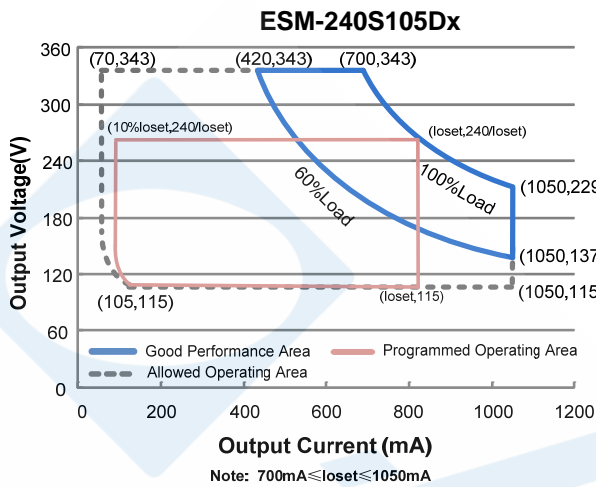

Input Specifications

Parameter	Min.	Typ.	Max.	Notes
Input AC Voltage	249 Vac	-	528 Vac	
Input AC Voltage	352 Vdc	-	500 Vdc	
Input Frequency	47 Hz	-	63 Hz	
Leakage Current	-	-	0.75 MIU	UL8750; 480Vac/ 60Hz
	-	-	0.70 mA	IEC60598-1; 480Vac/ 60Hz,
Input AC Current	-	-	1.1 A	Measured at 100%load and 277 Vac input.
	-	-	0.66 A	Measured at 100%load and 480 Vac input.
Inrush Current(I^2t)	-	-	2.095 A ² s	At 480Vac input, 25°C cold start, duration=520 μs, 10%Ipk-10%Ipk. See Inrush Current Waveform for the details.

Input Specifications (Continued)

Parameter	Min.	Typ.	Max.	Notes
PF	0.9	-	-	At 277-480Vac, 50-60Hz, 60%-100%load (144-240W)
THD	-	-	20%	

Output Specifications

Parameter	Min.	Typ.	Max.	Notes
Output Current Tolerance	-5%loset	-	5%loset	At 100%load condition
Output Current Setting(loset) Range				
ESM-240S105Dx	70 mA	-	1050 mA	
ESM-240S150Dx	105 mA	-	1500 mA	
ESM-240S350Dx	215 mA	-	3500 mA	
ESM-240S670Dx	420 mA	-	6700 mA	
Output Current Setting Range with Constant Power				
ESM-240S105Dx	700 mA	-	1050 mA	
ESM-240S150Dx	1050 mA	-	1500 mA	
ESM-240S350Dx	2150 mA	-	3500 mA	
ESM-240S670Dx	4200 mA	-	6700 mA	
Total Output Current Ripple (pk-pk)	-	5%lomax	10%lomax	At 100%load condition. 20 MHz BW
Output Current Ripple at < 200 Hz (pk-pk)	-	2%lomax	-	At 100%load condition. Only this component of ripple is associated with visible flicker.
Startup Overshoot Current	-	-	10%lomax	At 100%load condition
No Load Output Voltage				
ESM-240S105Dx	-	-	380 V	
ESM-240S150Dx	-	-	260 V	
ESM-240S350Dx	-	-	120 V	
ESM-240S670Dx	-	-	70 V	
Line Regulation	-	-	±0.5%	Measured at 100%load
Load Regulation	-	-	±1.5%	
Turn-on Delay Time	-	-	0.5 s	Measured at 277-480Vac input, 60%-100%load
Temperature Coefficient of loset	-	0.03%/°C	-	Case temperature = 0°C ~Tc max

General Specifications

Parameter	Min.	Typ.	Max.	Notes	
Efficiency at 277 Vac input: ESM-240S105Dx I _o = 700 mA I _o =1050 mA ESM-240S150Dx I _o =1050 mA I _o =1500 mA ESM-240S350Dx I _o =2150 mA I _o =3500 mA ESM-240S670Dx I _o =4200 mA I _o =6700 mA	91.5% 91.0% 90.5% 90.5% 91.0% 89.5% 89.5% 88.5%	93.5% 93.0% 92.5% 92.5% 93.0% 91.5% 91.5% 90.5%	- - - - - - - -	Measured at 100%load and steady-state temperature in 25°C ambient; (Efficiency will be about 2.0% lower if measured immediately after startup.)	
Efficiency at 400 Vac input: ESM-240S105Dx I _o = 700 mA I _o =1050 mA ESM-240S150Dx I _o =1050 mA I _o =1500 mA ESM-240S350Dx I _o =2150 mA I _o =3500 mA ESM-240S670Dx I _o =4200 mA I _o =6700 mA	92.5% 91.5% 91.5% 91.5% 92.0% 90.5% 90.5% 89.0%	94.5% 93.5% 93.5% 93.5% 94.0% 92.5% 92.5% 91.0%	- - - - - - - -		
Efficiency at 480 Vac input: ESM-240S105Dx I _o = 700 mA I _o =1050 mA ESM-240S150Dx I _o =1050 mA I _o =1500 mA ESM-240S350Dx I _o =2150 mA I _o =3500 mA ESM-240S670Dx I _o =4200 mA I _o =6700 mA	92.5% 92.0% 92.0% 91.5% 92.0% 91.0% 91.0% 89.5%	94.5% 94.0% 94.0% 93.5% 94.0% 93.0% 93.0% 91.5%	- - - - - - - -		
MTBF	-	240,000 Hours	-		Measured at 480Vac input, 80%load and 25°C ambient temperature (MIL-HDBK-217F)
Lifetime	-	100,000 Hours	-		Measured at 480Vac input, 80%load and 70°C case temperature; See lifetime vs. T _c curve for the details
Operating Case Temperature for Safety T _{c_s}	-40°C	-	+90°C		
Operating Case Temperature for Warranty T _{c_w}	-40°C	-	+80°C		Case temperature for 5 years warranty Humidity: 10% RH to 95% RH;
Storage Temperature	-40°C	-	+85°C		Humidity: 5%RH to 95%RH;
Dimensions: Inches (L × W × H) Millimeters (L × W × H)	7.91 × 2.66 × 1.52 201 × 67.5 × 38.5				With mounting ear 8.58 × 2.66 × 1.52 218 × 67.5 × 38.5
Net Weight	-	1120 g	-		

Dimming Specifications

Parameter	Min.	Typ.	Max.	Notes	
Absolute Maximum Voltage on the Vdim (+) Pin	-20 V	-	20 V		
Source Current on Vdim (+)Pin	200 μ A	300 μ A	450 μ A	Vdim(+) = 0 V	
Dimming Output Range	ESM-240S105Dx ESM-240S150Dx ESM-240S350Dx ESM-240S670Dx	10% <i>loset</i>	-	<i>loset</i>	700 mA \leq <i>loset</i> \leq 1050 mA 1050 mA \leq <i>loset</i> \leq 1500 mA 2150 mA \leq <i>loset</i> \leq 3500 mA 4200 mA \leq <i>loset</i> \leq 6700 mA
	ESM-240S105Dx ESM-240S150Dx ESM-240S350Dx ESM-240S670Dx	70 mA 105 mA 215 mA 420 mA	-	<i>loset</i>	70 mA \leq <i>loset</i> < 700 mA 105 mA \leq <i>loset</i> < 1050 mA 215 mA \leq <i>loset</i> < 2150 mA 420 mA \leq <i>loset</i> < 4200 mA
Recommended Dimming Range for 1-10V	1 V	-	9 V	Default 1-10V dimming mode with positive logic.	
PWM_in High Level	-	10V	-		
PWM_in Low Level	-	0V	-		
PWM_in Frequency Range	200 Hz	-	2 KHz		
PWM_in Duty Cycle	0%	-	100%		

Safety & EMC Compliance

Safety Category	Standard
UL/CUL	UL8750,CAN/CSA-C22.2 No. 250.13
ENEC & CE	EN 61347-1, EN61347-2-13
CB	IEC 61347-1, IEC 61347-2-13
EMI Standards	Notes
EN 55015 ⁽¹⁾	Conducted emission Test & Radiated emission Test
EN 61000-3-2	Harmonic current emissions
EN 61000-3-3	Voltage fluctuations & flicker
FCC Part 15 ⁽¹⁾	ANSI C63.4 Class B
	This device complies with Part 15 of the FCC Rules. Operation is subject to the following two conditions: [1] this device may not cause harmful interference, and [2] this device must accept any interference received, including interference that may cause undesired operation.
EMS Standards	Notes
EN 61000-4-2	Electrostatic Discharge (ESD): 8 kV air discharge, 4 kV contact discharge
EN 61000-4-3	Radio-Frequency Electromagnetic Field Susceptibility Test-RS
EN 61000-4-4	Electrical Fast Transient / Burst-EFT
EN 61000-4-5	Surge Immunity Test: AC Power Line: Differential Mode 6 kV, Common Mode 10 kV

Safety & EMC Compliance (Continued)

EMS Standards	Notes
EN 61000-4-6	Conducted Radio Frequency Disturbances Test-CS
EN 61000-4-8	Power Frequency Magnetic Field Test
EN 61000-4-11	Voltage Dips
EN 61547	Electromagnetic Immunity Requirements Applies To Lighting Equipment

Note: (1) This LED driver meets the EMI specifications above, but EMI performance of a luminaire that contains it depends also on the other devices connected to the driver and on the fixture itself.

Lifetime vs. Case Temperature

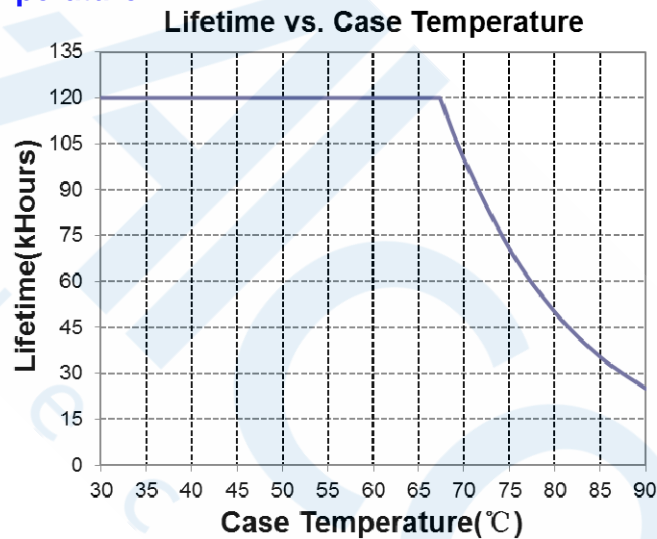

Inrush Current Waveform

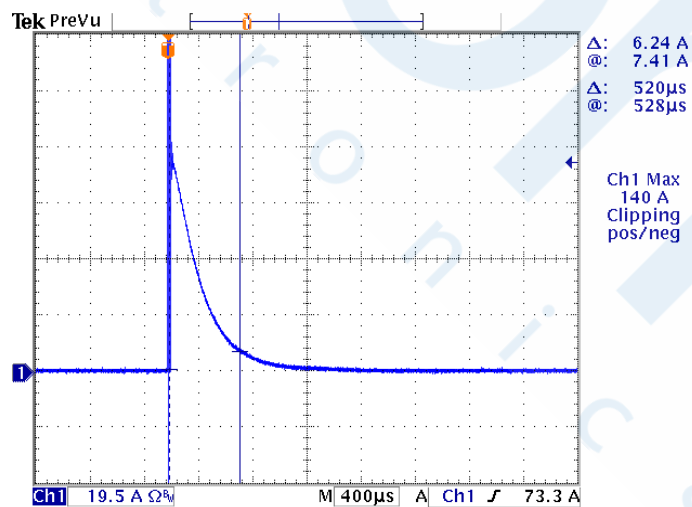

Efficiency vs. Load

ESM-240S105Dx($I_o=700mA$)

Efficiency vs. Output Voltage

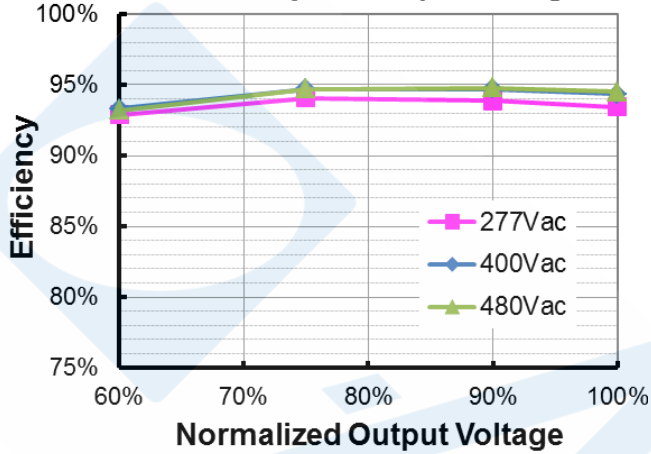

ESM-240S105Dx($I_o=1050mA$)

Efficiency vs. Output Voltage

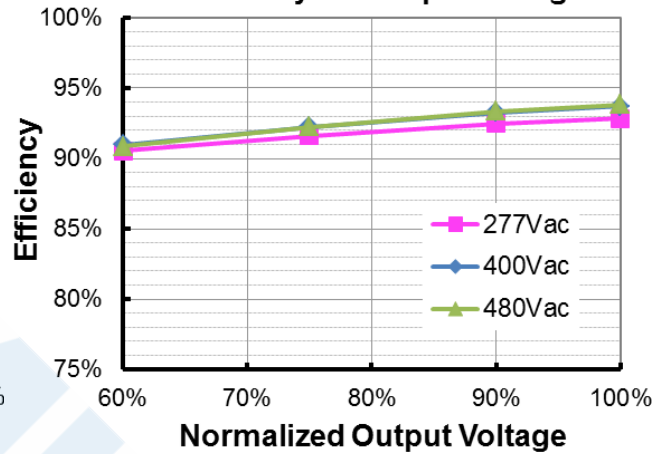

ESM-240S150Dx($I_o=1050mA$)

Efficiency vs. Output Voltage

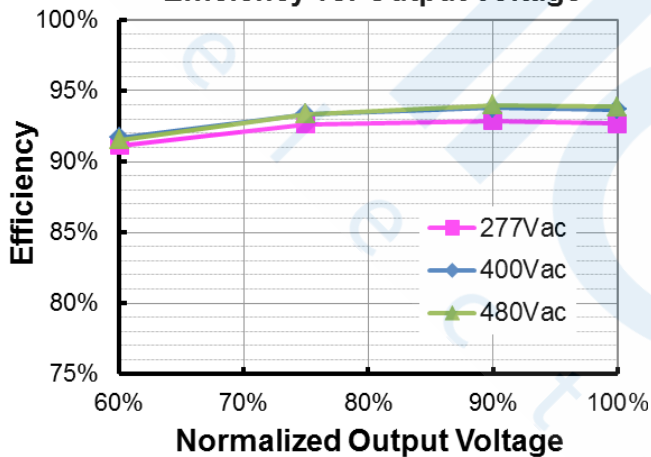

ESM-240S150Dx($I_o=1500mA$)

Efficiency vs. Output Voltage

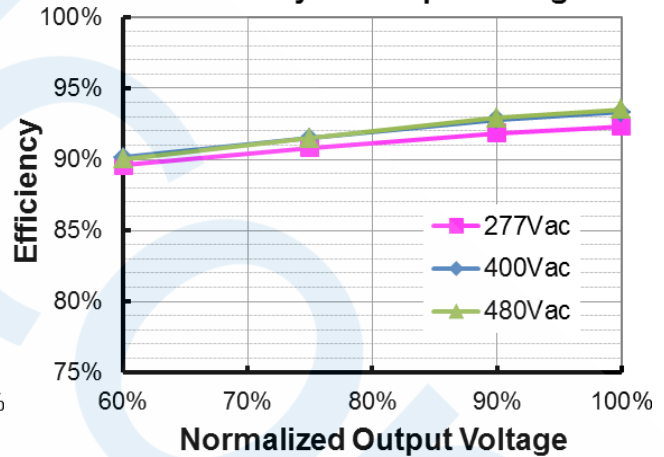

ESM-240S350Dx($I_o=2150mA$)
Efficiency vs. Output Voltage

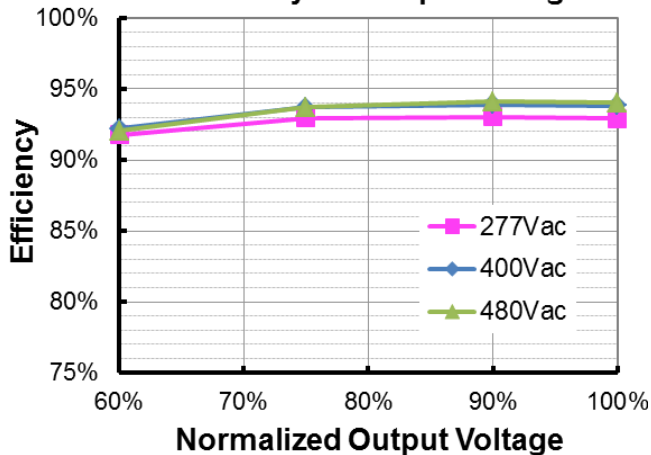

ESM-240S350Dx($I_o=3500mA$)
Efficiency vs. Output Voltage

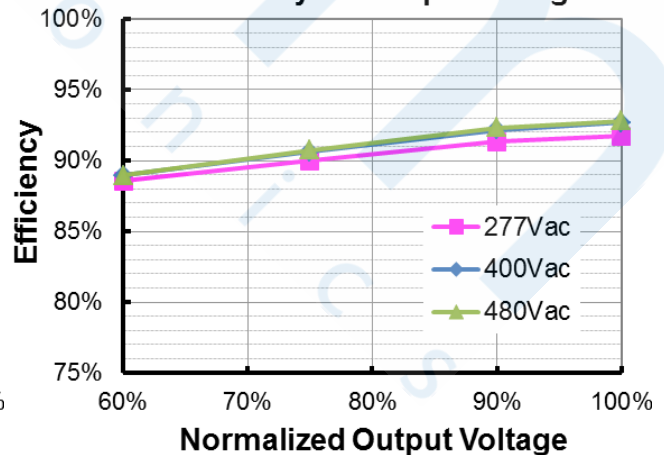

ESM-240S670Dx($I_o=4200mA$)
Efficiency vs. Output Voltage

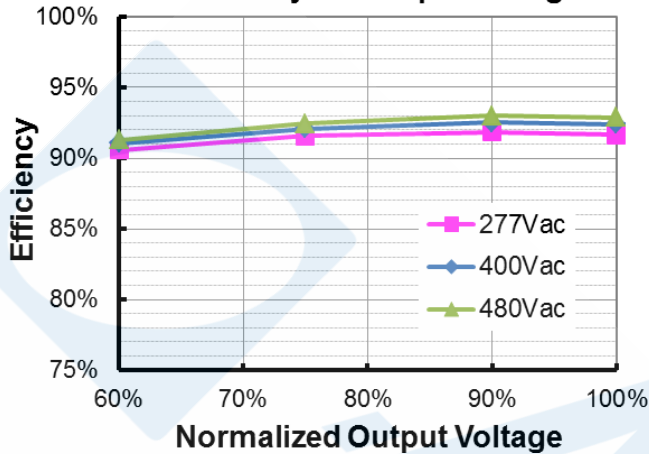

ESM-240S670Dx($I_o=6700mA$)
Efficiency vs. Output Voltage

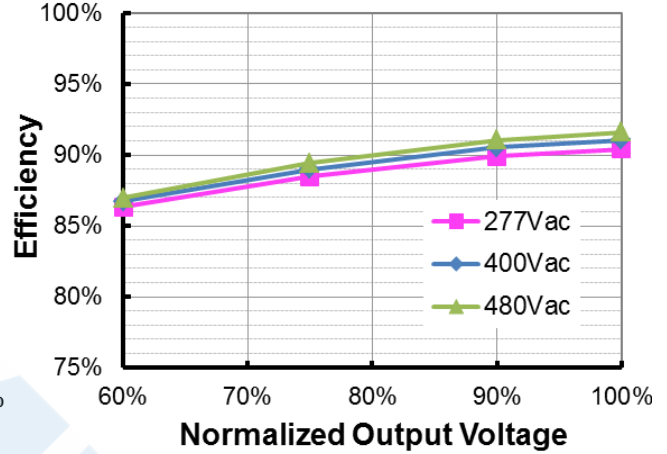

Power Factor

PF vs. Load

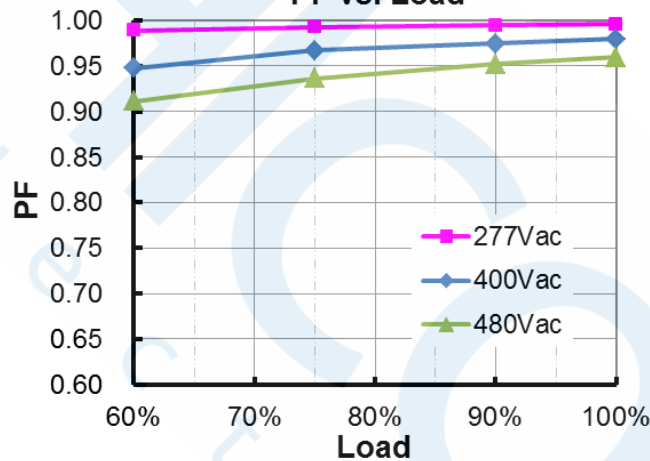

Total Harmonic Distortion

THD vs. Load

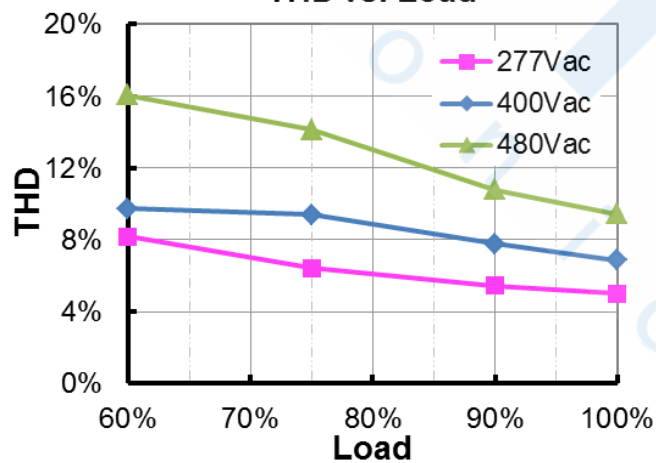

Protection Functions

Parameter	Notes
Over Voltage Protection	Limits output voltage at no load and in case the normal voltage limit fails.
Short Circuit Protection	Auto Recovery. No damage will occur when any output is short circuited. The output shall return to normal when the fault condition is removed.
Over Temperature Protection	Decreases output current, returning to normal after over temperature is removed.

Dimming

● 1-10V Dimming

The recommended implementation of the dimming control is provided below.

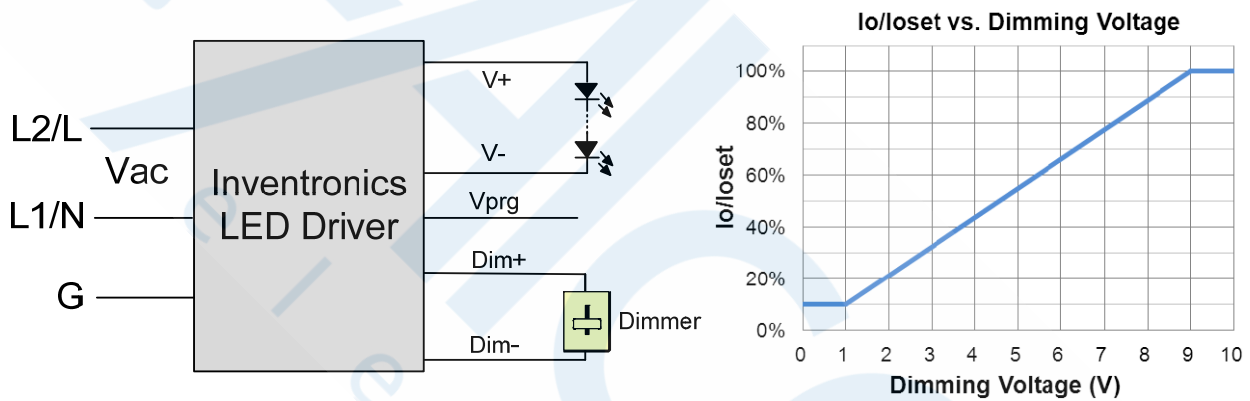

Implementation 1: Positive logic

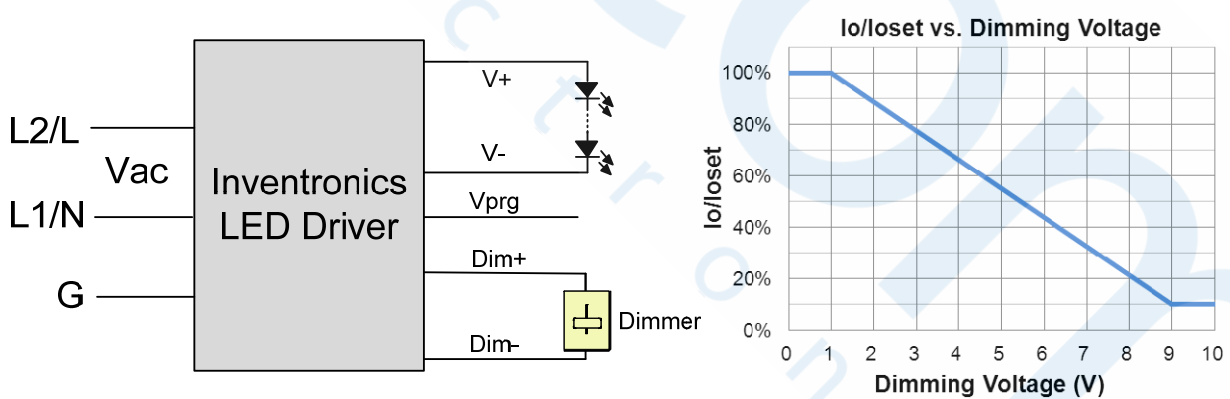

Implementation 2: Negative logic

Notes:

1. The dimmer can also be replaced by an active 1-10V voltage source signal or passive components like zener.
2. If 1-10V dimming is not used, Dim + should be open.
3. When 1-10V negative logic dimming mode and Dim+ is open, the driver will output minimum current.

● 10V PWM Dimming

The recommended implementation of the dimming control is provided below.

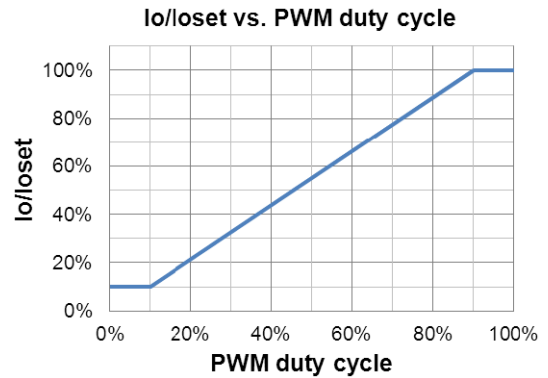
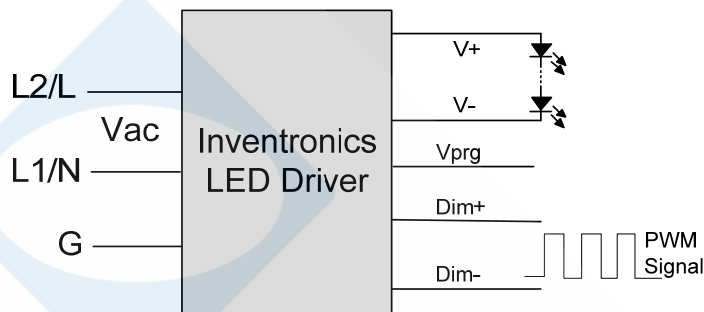

Implementation 3: Positive logic

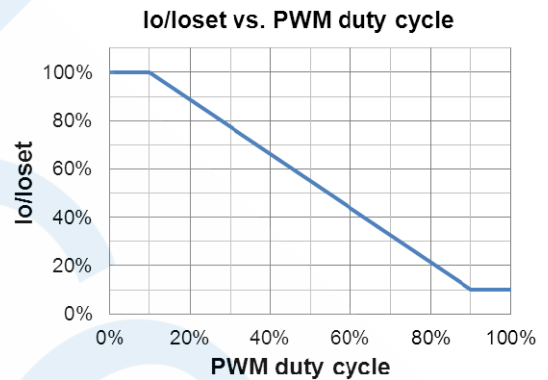
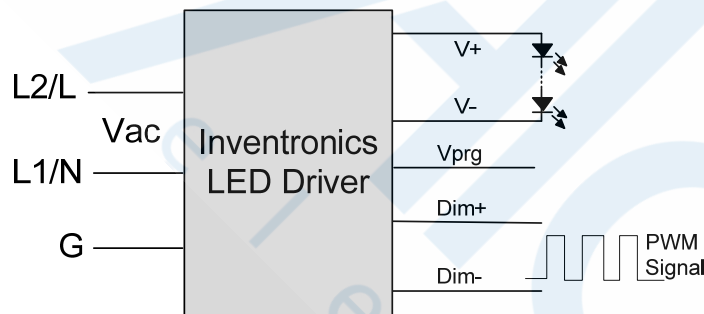

Implementation 4: Negative logic

Notes:

1. If PWM dimming is not used, Dim + should be open.
2. When PWM negative logic dimming mode and Dim+ is open, the driver will output minimum current.

● Time Dimming

Time dimming control includes 3 kinds of modes, they are Self Adapting-Midnight, Self Adapting-Percentage and Traditional Timer.

- **Self Adapting-Midnight:** Automatically adjusts the dimming curve based on the on-time of past two days (if difference <15 minutes), assuming that the center point of the dimming curve is midnight local time.
- **Self Adapting-Percentage:** Automatically adjusts the on-time of each step by a constant percentage = (actual on-time for the past 2 days if difference <15 min) / (programmed on-time from the dimming curve).
- **Traditional Timer:** Follows the programmed timing curve after power on with no changes.

● Output Lumen Compensation

Output Lumen Compensation (OLC) may be used to maintain constant light output over the life of the LEDs by driving them at a reduced current when new, then gradually increasing the drive current over time to counteract LED lumen degradation.

● **End Of Life**

End-of-Life (EOL) is providing a visual notification to a user that the LED module has reached the end of manufacturer-specified life and that the replacement is recommended. Once active, an indication is given at each power-up of the driver, which the driver indicates this through a lower light output during the first 1 minute before normal operation is continued.

Programming Connection Diagram

ESM-240SxxxDG

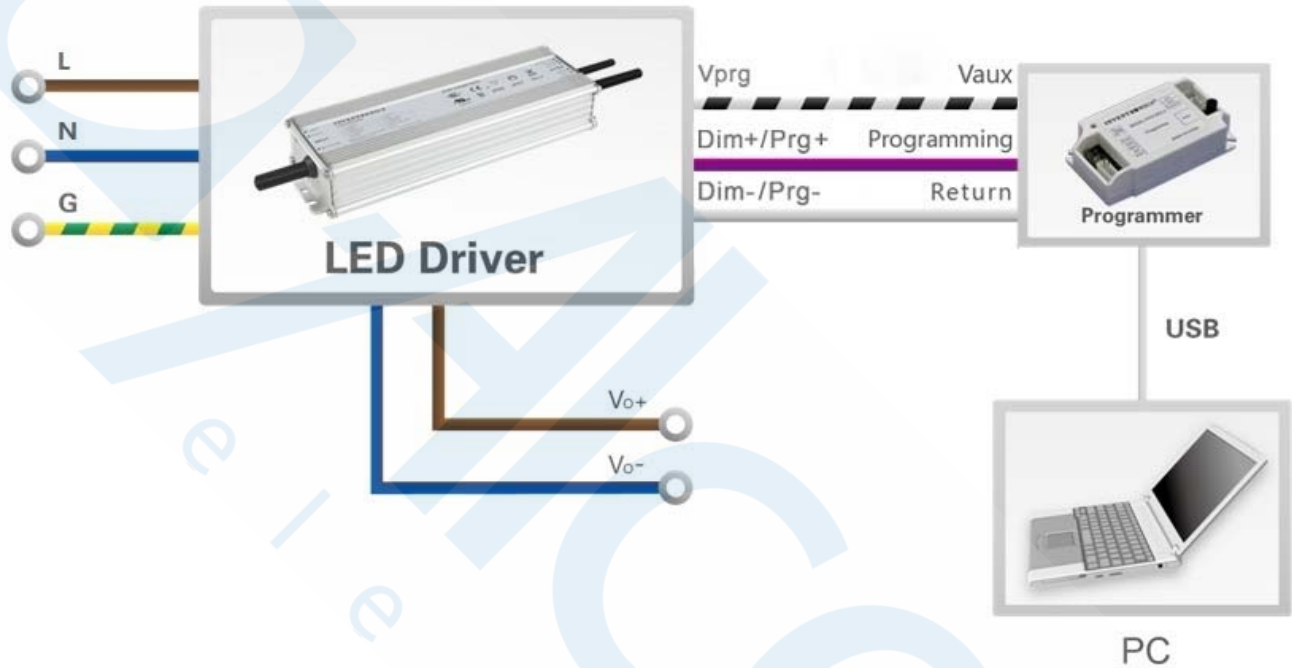

ESM-240SxxxDT

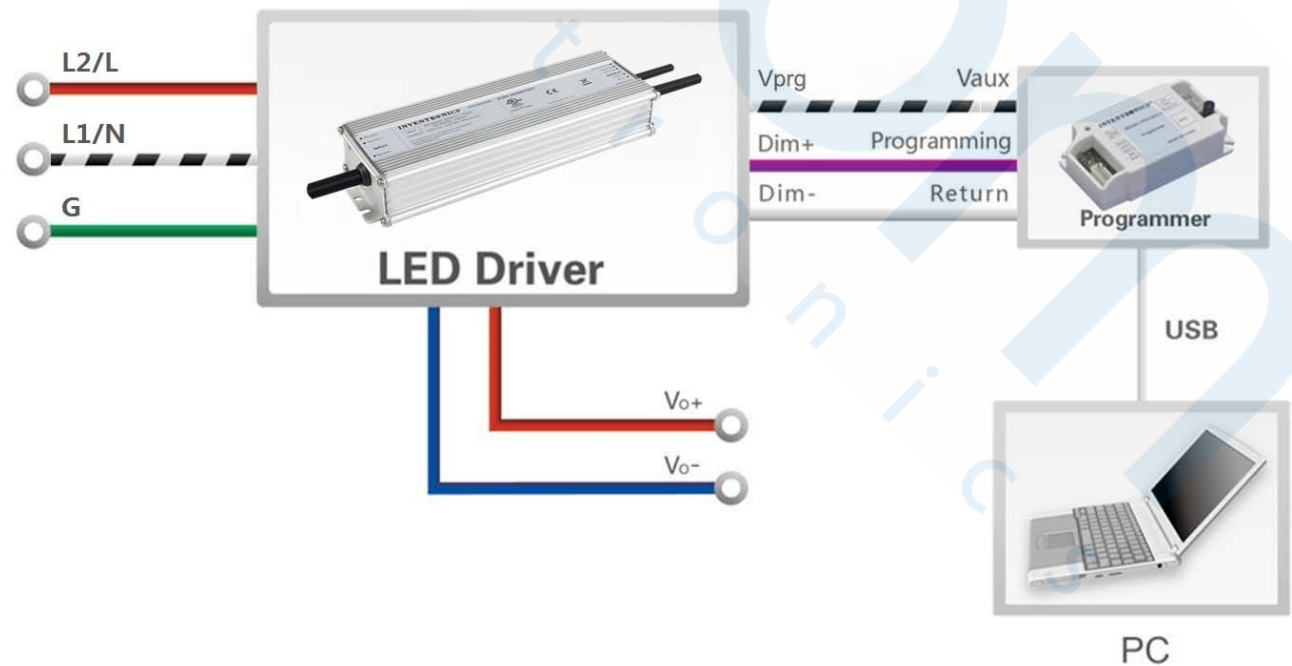

Note: The driver does not need to be powered on during the programming process.

- Please refer to [PRG-MUL2](#) (Programmer) datasheet for details.

Mechanical Outline

ESM-240SxxxDG

INPUT(UL SOOW 17AWG/3C & VDE H07RN-F 3*1.0mm² Ø9.8)

Dimming Wire(UL21996 22AWG/3C Ø5.0)

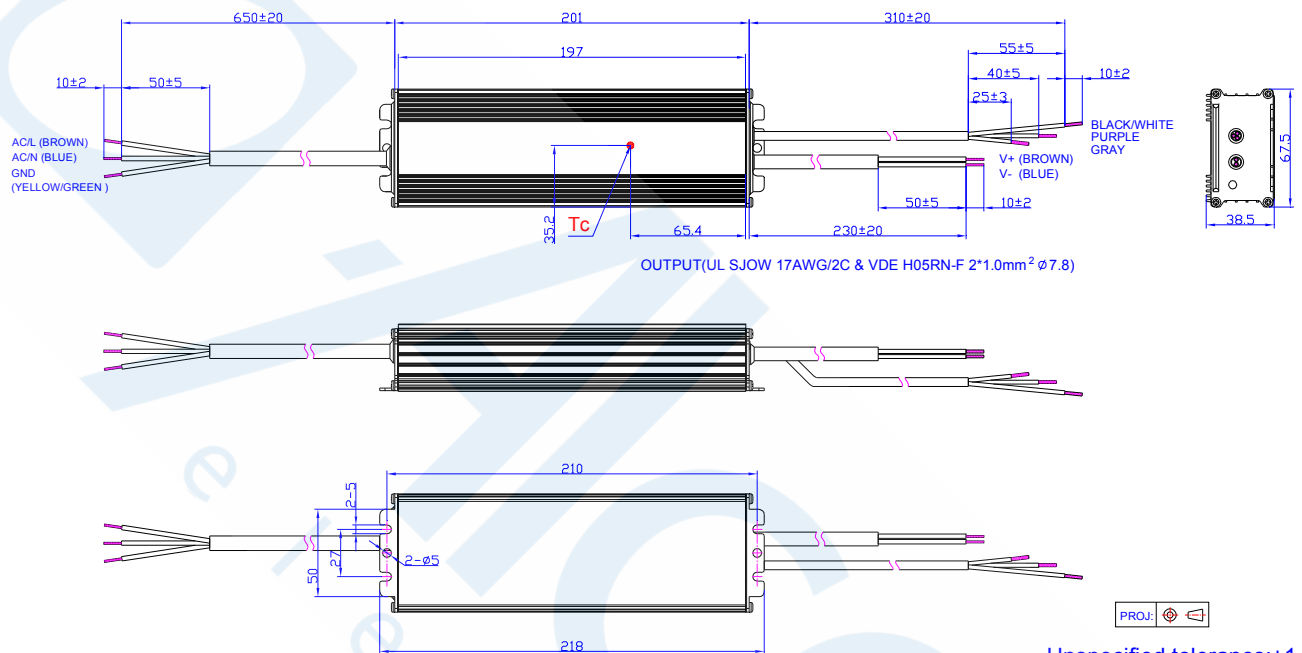

ESM-240SxxxDT

INPUT(UL STW 18AWG/3C Ø9.5)

Dimming Wire(UL21996 22AWG/3C Ø5.0)

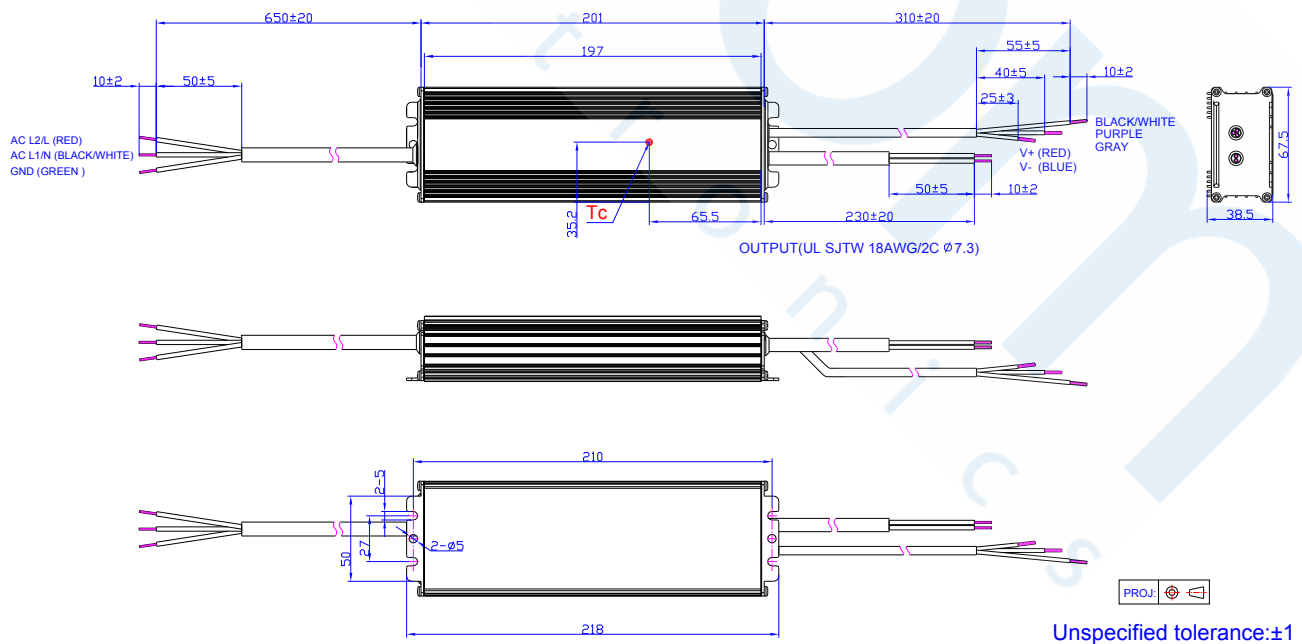

RoHS Compliance

Our products comply with reference to RoHS Directive (EU) 2015/863 amending 2011/65/EU, calling for the elimination of lead and other hazardous substances from electronic products.



Singel 3 | B-2550 Kontich | Belgium | Tel. +32 (0)3 458 30 33
info@alcom.be | www.alcom.be
Rivium 1e straat 52 | 2909 LE Capelle aan den IJssel | The Netherlands
Tel. +31 (0)10 288 25 00 | info@alcom.nl | www.alcom.nl

Specifications are subject to changes without notice.

All specifications are typical at 25°C unless otherwise stated.

Revision History

Change Date	Rev.	Description of Change		
		Item	From	To
2020-07-09	A	Datasheet Release	/	/



Singel 3 | B-2550 Kontich | Belgium | Tel. +32 (0)3 458 30 33
info@alcom.be | www.alcom.be
Rivium 1e straat 52 | 2909 LE Capelle aan den IJssel | The Netherlands
Tel. +31 (0)10 288 25 00 | info@alcom.nl | www.alcom.nl