

## Features

- Compact Metal Case with Excellent Thermal Performance
- Full Power at Wide Output Current Range (Constant Power)
- Adjustable Output Current (AOC) with Programmability
- Isolated 1-5V/1-10V/10V PWM/3-Timer-Modes Dimmable
- Output Lumen Compensation
- Input Surge Protection: DM 6kV, CM 10kV
- All-Around Protection: OVP, SCP, OTP
- IP66 / IP67 and UL Dry / Damp / Wet Location
- Class 2 & SELV Output
- TYPE HL, for use in a Class I, Division 2 hazardous (Classified) location
- 5 Years Warranty



## Description

The *EUM-075SxxxDG* series is a 75W, constant-current, programmable IP67 LED driver that operates from 90-305Vac input with excellent power factor. It is created for many lighting applications including high bay, tunnel and roadway lights, etc. The high efficiency of these drivers and compact metal case enables them to run cooler, significantly improving reliability and extending product life. To ensure trouble-free operation, protection is provided against input surge, output over voltage, short circuit, and over temperature.

## Models

Adjustable Output Current Range	Full-Power Current Range (1)	Default Output Current	Input Voltage Range(2)	Output Voltage Range	Max. Output Power	Typical Efficiency (3)	Power Factor		Model Number (6)
							120Vac	220Vac	
70-1050mA	700-1050mA	700 mA	90~305 Vac/ 127~300 Vdc	36~107 Vdc	75W	90.5%	0.99	0.96	EUM-075S105DG <sup>(4)</sup>
105-1500mA	1050-1500mA	1050 mA	90~305 Vac/ 127~300 Vdc	25~72 Vdc	75W	90.5%	0.99	0.96	EUM-075S150DG <sup>(4)</sup>
140-2100mA	1400-2100mA	2100 mA	90~305 Vac/ 127~300 Vdc	18~54 Vdc	75W	89.5%	0.99	0.96	EUM-075S210DG <sup>(5)</sup>

- Notes:** (1) Output current range with constant power at 75W  
 (2) Certified input voltage range: UL, FCC 100-277Vac; otherwise 100-240Vac.  
 (3) Measured at 100% load and 220Vac input (see below "General Specifications" for details).  
 (4) SELV Output.  
 (5) Class 2 & SELV output.  
 (6) To order BIS approved model, please use suffix "DB" in place of "DG" (ex: EUM-075S105DB).

## I-V Operation Area

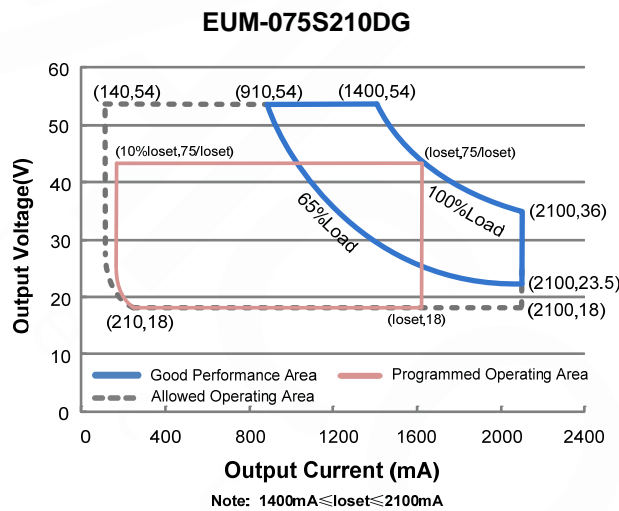
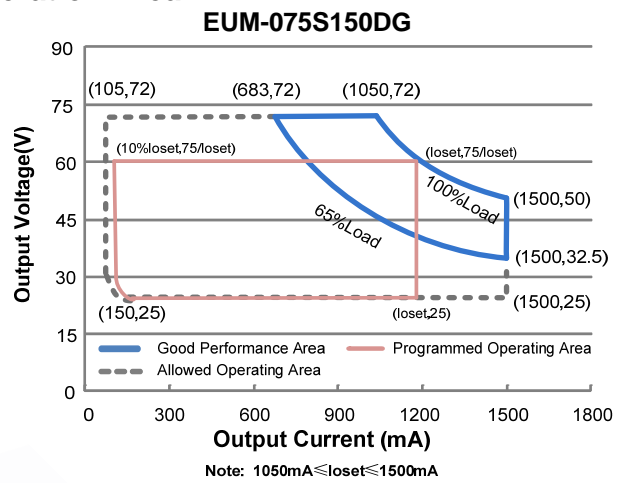
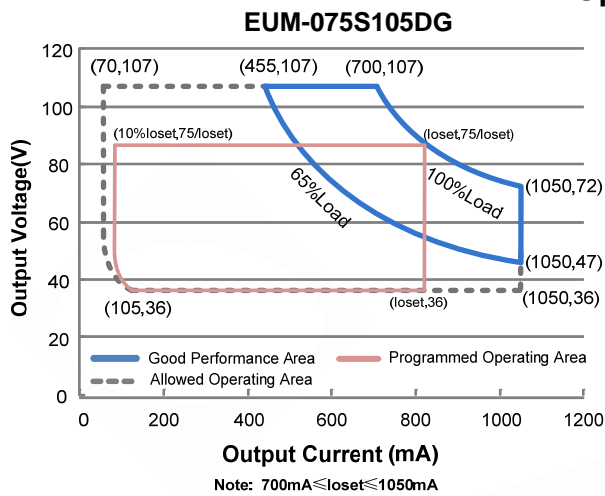

## Input Specifications

Parameter	Min.	Typ.	Max.	Notes
Input Voltage	90 Vac	-	305 Vac	127~300 Vdc
Input Frequency	47 Hz	-	63 Hz	
Leakage Current	-	-	0.75 MIU	UL8750; 277Vac/ 60Hz
	-	-	0.70 mA	IEC60598-1; 240Vac/ 60Hz,
Input AC Current	-	-	0.79 A	Measured at 100% load and 120 Vac input.
	-	-	0.43 A	Measured at 100% load and 220 Vac input.
Inrush Current(I <sup>2</sup> t)	-	-	0.90 A <sup>2</sup> s	At 220Vac input, 25°C cold start, duration=284 μs, 10%I <sub>pk</sub> -10%I <sub>pk</sub> . See Inrush Current Waveform for the details.

## Input Specifications (Continued)

Parameter	Min.	Typ.	Max.	Notes
PF	0.9	-	-	At 100-277Vac, 50-60Hz, 65%-100% Load (49-75W)
THD	-	-	20%	
THD	-	-	10%	At 220-240Vac, 50-60Hz, 75%-100% Load (56-75W)

## Output Specifications

Parameter	Min.	Typ.	Max.	Notes
Output Current Tolerance	-5%loset	-	5%loset	At 100% load condition
Output Current Setting(loset) Range				
EUM-075S105DG	70 mA	-	1050 mA	
EUM-075S150DG	105 mA	-	1500 mA	
EUM-075S210DG	140 mA	-	2100 mA	
Output Current Setting Range with Constant Power				
EUM-075S105DG	700 mA	-	1050 mA	
EUM-075S150DG	1050 mA	-	1500 mA	
EUM-075S210DG	1400 mA	-	2100 mA	
Total Output Current Ripple (pk-pk)	-	5%lomax	10%lomax	At 100% load condition. 20 MHz BW
Output Current Ripple at < 200 Hz (pk-pk)	-	2%lomax	-	At 100% load condition. Only this component of ripple is associated with visible flicker.
Startup Overshoot Current	-	-	10%lomax	At 100% load condition
No Load Output Voltage				
EUM-075S105DG	-	-	120 V	
EUM-075S150DG	-	-	90 V	
EUM-075S210DG	-	-	60 V	
Line Regulation	-	-	±1%	Measured at 100% load
Load Regulation	-	-	±5%	
Turn-on Delay Time	-	-	0.5 s	Measured at 120-277Vac input, 65%-100% Load
Temperature Coefficient of loset	-	0.06%/°C	-	Case temperature = 0°C ~Tc max

**Note:** All specifications are typical at 25°C unless otherwise stated.

## General Specifications

Parameter	Min.	Typ.	Max.	Notes
Efficiency at 120 Vac input: EUM-075S105DG I <sub>o</sub> = 700 mA I <sub>o</sub> =1050 mA EUM-075S150DG I <sub>o</sub> =1050 mA I <sub>o</sub> =1500 mA EUM-075S210DG I <sub>o</sub> =1400 mA I <sub>o</sub> =2100 mA	86.00% 86.50% 85.50% 86.00% 85.00% 85.00%	88.00% 88.50% 87.50% 88.00% 87.00% 87.00%	- - - - - -	Measured at 100% load and steady-state temperature in 25°C ambient; (Efficiency will be about 2.0% lower if measured immediately after startup.)
Efficiency at 220 Vac input: EUM-075S105DG I <sub>o</sub> = 700 mA I <sub>o</sub> =1050 mA EUM-075S150DG I <sub>o</sub> =1050 mA I <sub>o</sub> =1500 mA EUM-075S210DG I <sub>o</sub> =1400 mA I <sub>o</sub> =2100 mA	88.50% 88.50% 88.00% 88.50% 87.50% 87.50%	90.50% 90.50% 90.00% 90.50% 89.50% 89.50%	- - - - - -	Measured at 100% load and steady-state temperature in 25°C ambient; (Efficiency will be about 2.0% lower if measured immediately after startup.)
Efficiency at 277 Vac input: EUM-075S105DG I <sub>o</sub> = 700 mA I <sub>o</sub> =1050 mA EUM-075S150DG I <sub>o</sub> =1050 mA I <sub>o</sub> =1500 mA EUM-075S210DG I <sub>o</sub> =1400 mA I <sub>o</sub> =2100 mA	88.50% 89.00% 88.50% 88.50% 87.50% 88.00%	90.50% 91.00% 90.50% 90.50% 89.50% 90.00%	- - - - - -	Measured at 100% load and steady-state temperature in 25°C ambient; (Efficiency will be about 2.0% lower if measured immediately after startup.)
MTBF	-	521,000 Hours	-	Measured at 220Vac input, 80%Load and 25°C ambient temperature (MIL-HDBK-217F)
Lifetime	-	100,000 Hours	-	Measured at 220Vac input, 80%Load and 70°C case temperature; See lifetime vs. T <sub>c</sub> curve for the details
Operating Case Temperature for Safety T <sub>c_s</sub>	-40°C	-	+90°C	
Operating Case Temperature for Warranty T <sub>c_w</sub>	-40°C	-	+80°C	Case temperature for 5 years warranty
Storage Temperature	-40°C	-	+85°C	Humidity: 5%RH to 100%RH
Dimensions Inches (L × W × H) Millimeters (L × W × H)	4.92 × 2.36 × 1.34 125 × 60 × 34			With mounting ear 5.59 × 2.36 × 1.34 142 × 60 × 34
Net Weight	-	575 g	-	

**Note:** All specifications are typical at 25°C unless otherwise stated.

## Dimming Specifications

Parameter		Min.	Typ.	Max.	Notes
Absolute Maximum Voltage on the Vdim (+) Pin		-20 V	-	20 V	
Source Current on Vdim (+)Pin		200 uA	300 uA	450 uA	Vdim(+) = 0 V
Dimming Output Range	EUM-075S105DG EUM-075S150DG EUM-075S210DG	10%loset	-	loset	700 mA ≤ loset ≤ 1050 mA 1050 mA ≤ loset ≤ 1500 mA 1400 mA ≤ loset ≤ 2100 mA
	EUM-075S105DG EUM-075S150DG EUM-075S210DG	70 mA 105 mA 140 mA	-	loset	70 mA ≤ loset < 700 mA 105 mA ≤ loset < 1050 mA 140 mA ≤ loset < 1400 mA
Recommended Dimming Range for 1-5V		0.25 V	-	4.75 V	Dimming mode set to 1-5V in PC interface.
Recommended Dimming Range for 1-10V		1 V	-	9 V	Default 1-10V dimming mode with positive logic.
PWM_in High Level		-	10V	-	
PWM_in Low Level		-	0V	-	
PWM_in Frequency Range		200 Hz	-	2 KHz	
PWM_in Duty Cycle		0%	-	100%	

## Safety & EMC Compliance

Safety Category	Standard
UL/CUL	UL8750,CAN/CSA-C22.2 No. 250.13
ENEC & CE	EN 61347-1, EN61347-2-13
CB	IEC 61347-1, IEC 61347-2-13
CCC	GB 19510.1, GB 19510.14
PSE	J 61347-1, J 61347-2-13
KS	KS C 7655
BIS	IS 15885(Part2/Sec13)
EAC	ГОСТ Р МЭК 61347-1, ГОСТ IEC 61347-2-13
EMI Standards	Notes
EN 55015/GB 17743/KN 15 <sup>(1)</sup>	Conducted emission Test &Radiated emission Test
EN 61000-3-2/GB 17625.1	Harmonic current emissions
EN 61000-3-3	Voltage fluctuations & flicker
FCC Part 15 <sup>(1)</sup>	ANSI C63.4 Class B
	This device complies with Part 15 of the FCC Rules. Operation is subject to the following two conditions: [1] this device may not cause harmful interference, and [2] this device must accept any interference received, including interference that may cause undesired Operation.

## Safety & EMC Compliance (Continued)

EMS Standards	Notes
EN 61000-4-2	Electrostatic Discharge (ESD): 8 kV air discharge, 4 kV contact discharge
EN 61000-4-3	Radio-Frequency Electromagnetic Field Susceptibility Test-RS
EN 61000-4-4	Electrical Fast Transient / Burst-EFT
EN 61000-4-5	Surge Immunity Test: AC Power Line: Differential Mode 6 kV, Common Mode 10 kV
EN 61000-4-6	Conducted Radio Frequency Disturbances Test-CS
EN 61000-4-8	Power Frequency Magnetic Field Test
EN 61000-4-11	Voltage Dips
EN 61547	Electromagnetic Immunity Requirements Applies To Lighting Equipment

**Note:** (1) This LED driver meets the EMI specifications above, but EMI performance of a luminaire that contains it depends also on the other devices connected to the driver and on the fixture itself.

## Derating

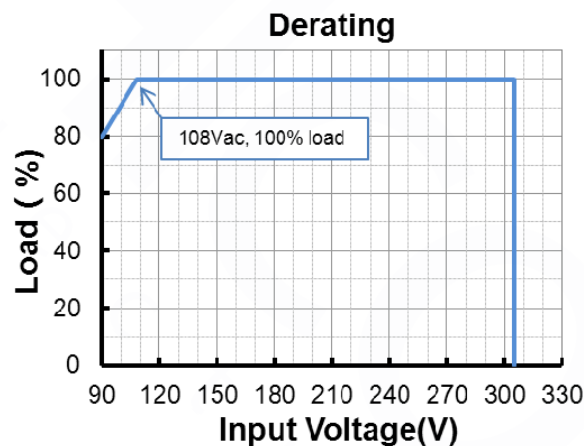

## Lifetime vs. Case Temperature

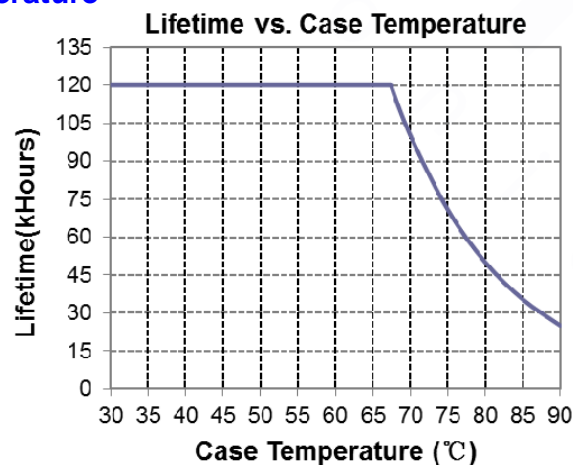

## Inrush Current Waveform

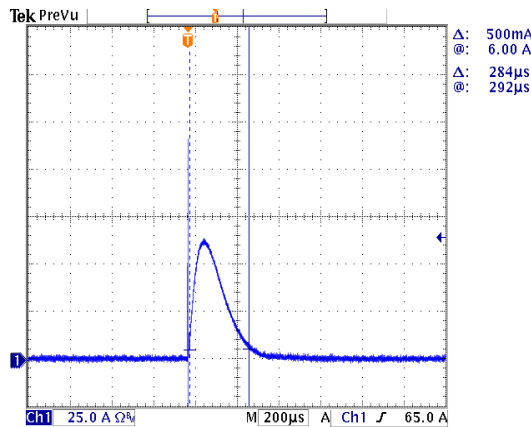

## Efficiency vs. Load

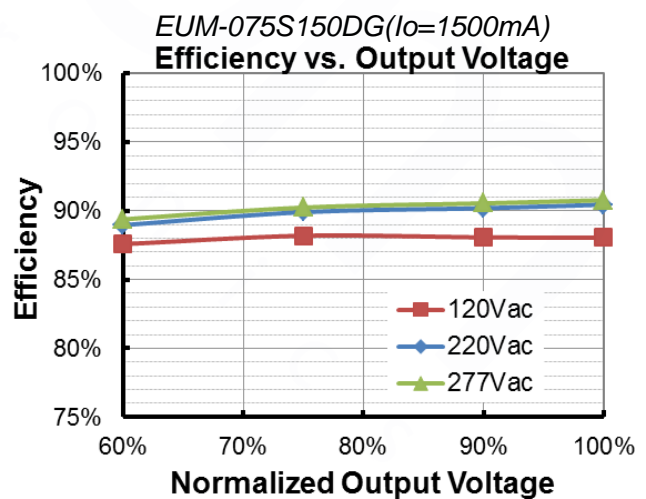
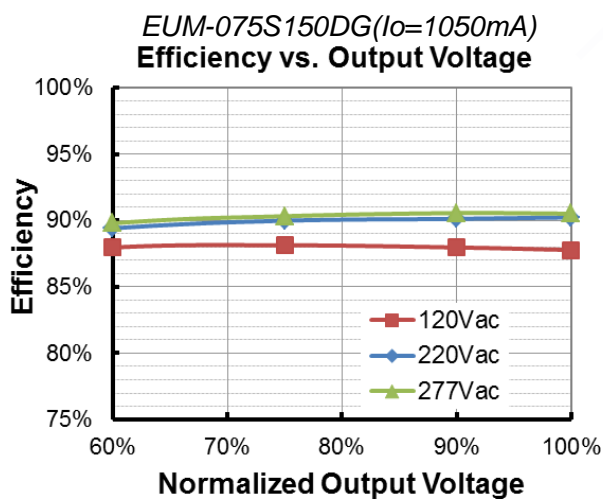
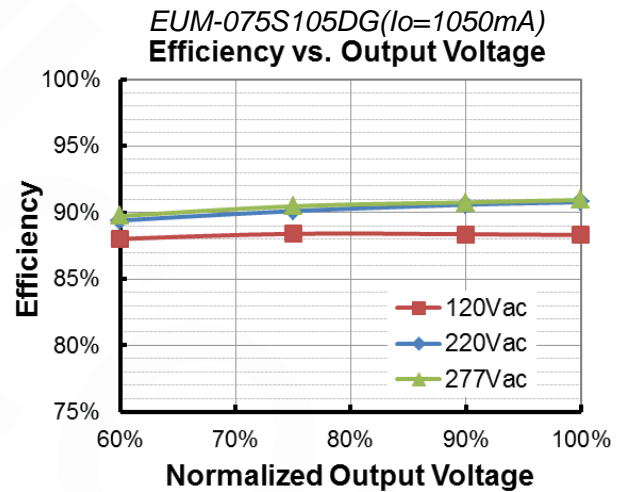
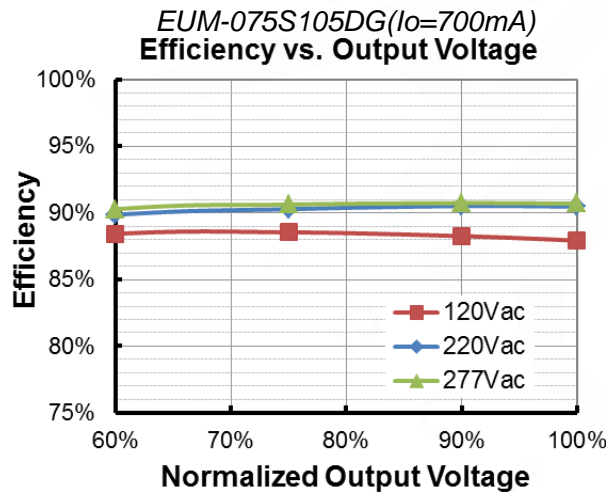

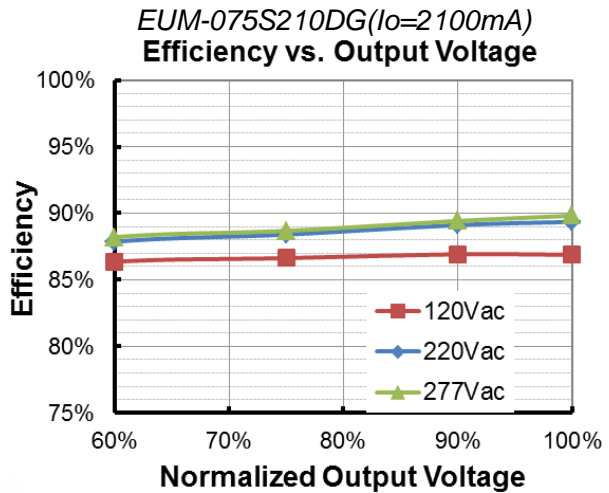
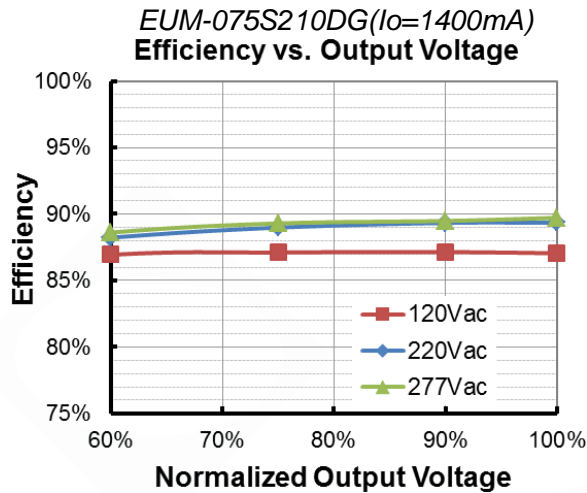

## Power Factor

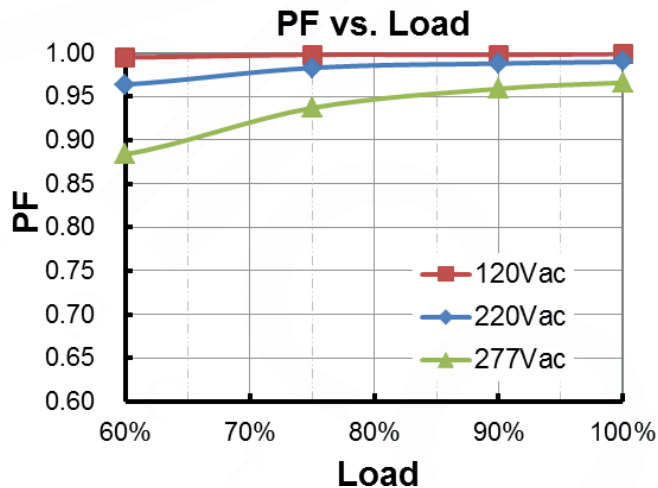

## Total Harmonic Distortion

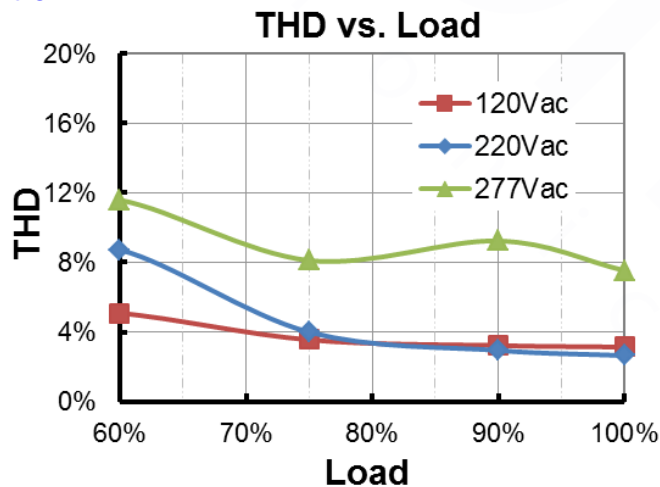



## Protection Functions

Parameter	Notes
Over Temperature Protection	Decreases output current, returning to normal after over temperature is removed.
Short Circuit Protection	Auto Recovery. No damage will occur when any output is short circuited. The output shall return to normal when the fault condition is removed.
Over Voltage Protection	Limits output voltage at no load and in case the normal voltage limit fails.

## Dimming

### ● 1-5V Dimming

The recommended implementation of the dimming control is provided below.

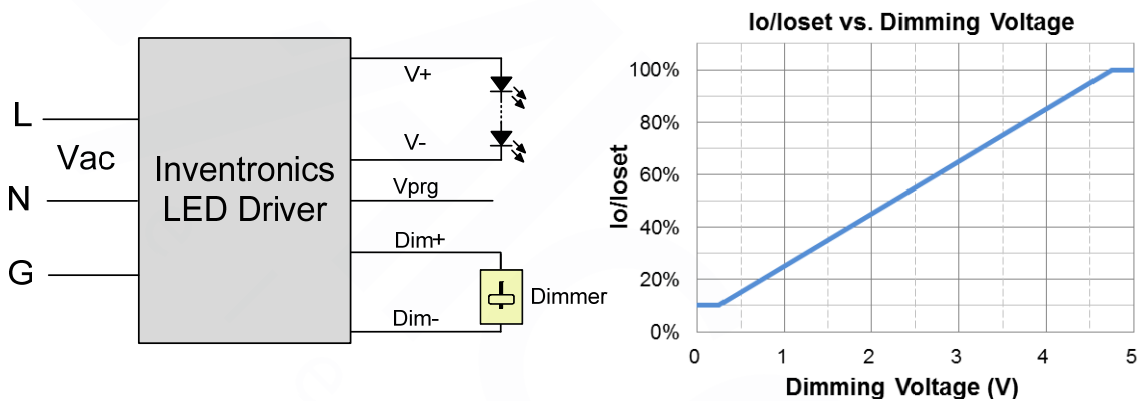

**Implementation 1: Positive logic**

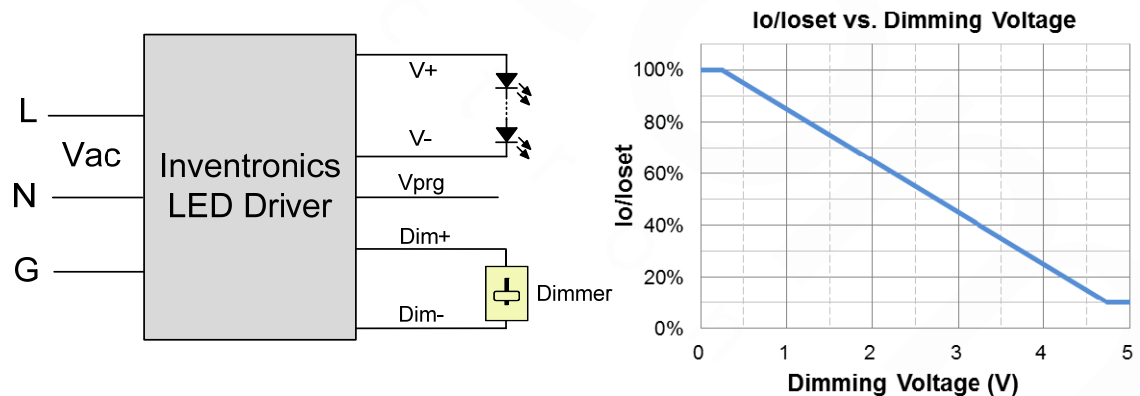

**Implementation 2: Negative logic**

### Notes:

1. The dimmer can also be replaced by an active 1-5V voltage source signal or passive components like resistors and zener.
2. If 1-5V dimming is not used, Dim + should be open.
3. When 1-5V negative logic dimming mode and Dim+ is open, the driver will output maximum current.

## ● 1-10V Dimming

The recommended implementation of the dimming control is provided below.

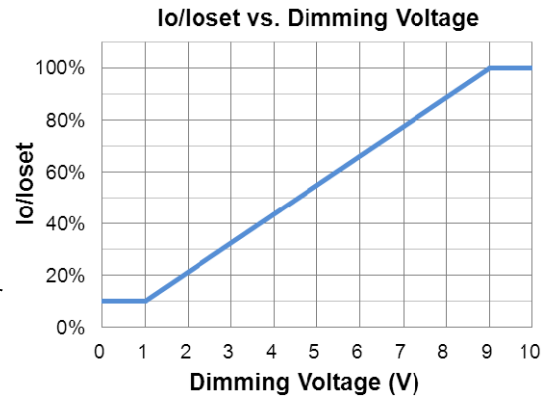
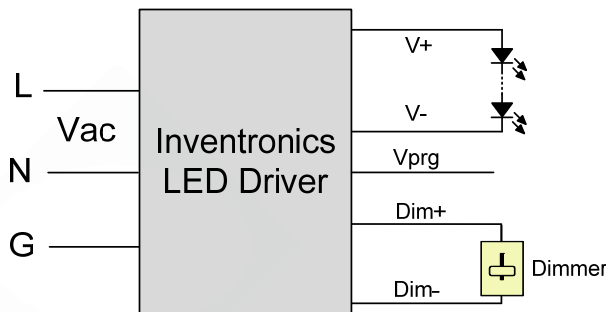

**Implementation 3: Positive logic**

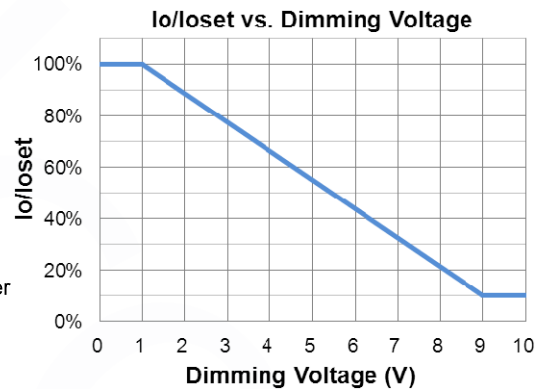
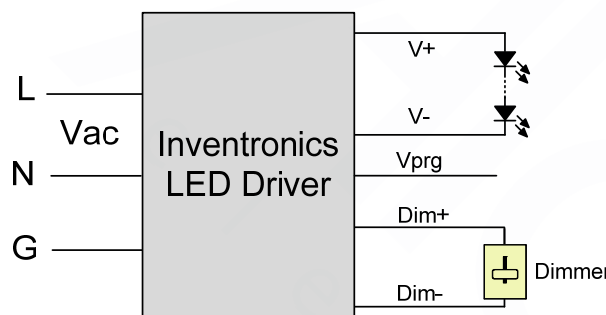

**Implementation 4: Negative logic**

### Notes:

1. The dimmer can also be replaced by an active 1-10V voltage source signal or passive components like resistors and zener.
2. If 1-10V dimming is not used, Dim + should be open.
3. When 1-10V negative logic dimming mode and Dim+ is open, the driver will output minimum current.

## ● 10V PWM Dimming

The recommended implementation of the dimming control is provided below.

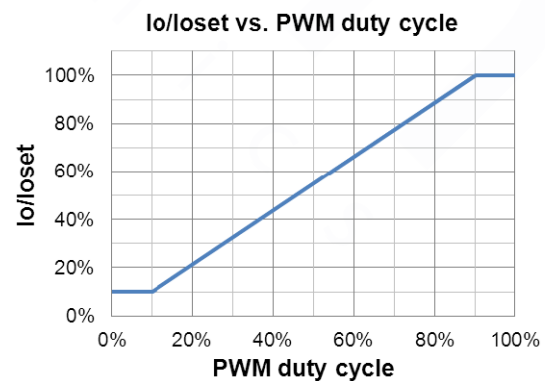
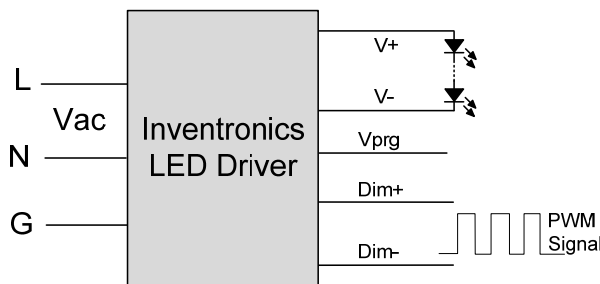

**Implementation 5: Positive logic**

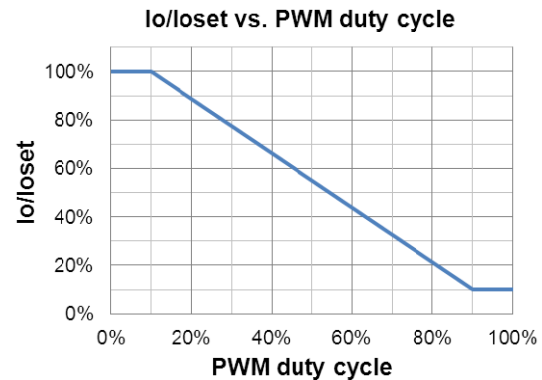
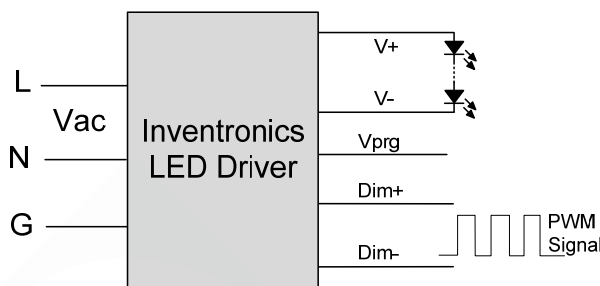

### Implementation 6: Negative logic

#### Notes:

1. If PWM dimming is not used, Dim + should be open.
2. When PWM negative logic dimming mode and Dim+ is open, the driver will output minimum current.

#### ● Time Dimming

Time dimming control includes 3 kinds of modes, they are Self Adapting-Midnight, Self Adapting-Percentage and Traditional Timer.

- **Self Adapting-Midnight:** Automatically adjusts the dimming curve based on the on-time of past two days (if difference <15 minutes), assuming that the center point of the dimming curve is midnight local time.
- **Self Adapting-Percentage:** Automatically adjusts the on-time of each step by a constant percentage = (actual on-time for the past 2 days if difference <15 min) / (programmed on-time from the dimming curve).
- **Traditional Timer:** Follows the programmed timing curve after power on with no changes.

#### ● Output Lumen Compensation

Output Lumen Compensation (OLC) may be used to maintain constant light output over the life of the LEDs by driving them at a reduced current when new, then gradually increasing the drive current over time to counteract LED lumen degradation.



## Revision History

Change Date	Rev.	Description of Change		
		Item	From	To
2019-10-29	A	Datasheets Release	/	/

