

Features

- Full Power at Wide Output Current Range (Constant Power)
- Adjustable Output Current (AOC) with Programmability
- Isolated 0-10V/PWM/3-Timer-Modes Dimmable
- INV Digital Dimming, UART Based Communication Protocol
- Dim-to-Off with Standby Power ≤ 0.5 W
- Always-on Auxiliary Power:
12Vdc, 250mA, 3W (Transient Peak Power up to 10W)
- Output Lumen Compensation
- End-of-Life Indicator
- Input Surge Protection: DM 6kV, CM 10kV
- All-Around Protection: IUVP, IOVP, OVP, SCP, OTP
- IP66 / IP67 and UL Dry / Damp / Wet Location
- TYPE HL, for Use in a Class I, Division 2 Hazardous (Classified) Location
- 5 Years Warranty



Description

The *EUM-100SxxxMx* series is a 100W, constant-current, programmable and IP66/IP67 rated LED driver that operates from 90-305Vac input with excellent power factor. Created for smart lighting application, this family provides an auxiliary voltage and dim-to-off functionality for powering low voltage, wireless controls. The dimming control supports 0-10V dimming as well as two-way communication via Digital Dimming, a UART based communication protocol. The high efficiency of these drivers and compact metal case enables them to run cooler, significantly improving reliability and extending product life. To ensure trouble-free operation, protection is provided against input surge, input under voltage, input over voltage, output over voltage, short circuit, and over temperature.

Models

| Adjustable Output Current Range | Full-Power Current Range(1) | Default Output Current | Input Voltage Range(2) | Output Voltage Range | Max. Output Power | Typical Efficiency (3) | Typical Power Factor | | Model Number (6) |
|---------------------------------|-----------------------------|------------------------|----------------------------|----------------------|-------------------|------------------------|----------------------|--------|------------------------------|
| | | | | | | | 120Vac | 220Vac | |
| 70-1050mA | 700-1050mA | 700 mA | 90~305 Vac/ 127~300 Vdc | 48~143 Vdc | 100W | 92.5% | 0.99 | 0.96 | EUM-100S105Mx |
| 105-1500mA | 1050-1500mA | 1050 mA | 90~305 Vac/ 127~300 Vdc | 34~95 Vdc | 100W | 92.5% | 0.99 | 0.96 | EUM-100S150Mx ⁽⁴⁾ |
| 175-2800mA | 1750-2800mA | 2100 mA | 90~305 Vac/ 127~300 Vdc | 17~54 Vdc | 96W | 91.0% | 0.99 | 0.96 | EUM-100S280Mx ⁽⁵⁾ |

- Notes:** (1) Output current range with constant power at 100W
 (2) Certified input voltage range: UL, FCC 100-277Vac; otherwise 100-240Vac.
 (3) Measured at 100% load and 220Vac input (see below "General Specifications" for details).
 (4) SELV output.
 (5) Class 2 & SELV output.
 (6) x = G are UL Recognized, ENEC and CCC, etc. models; x = T are UL Class P models;

I-V Operation Area

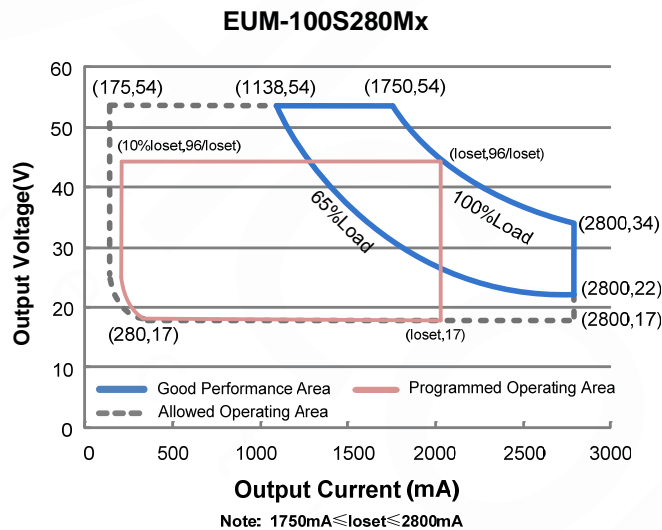
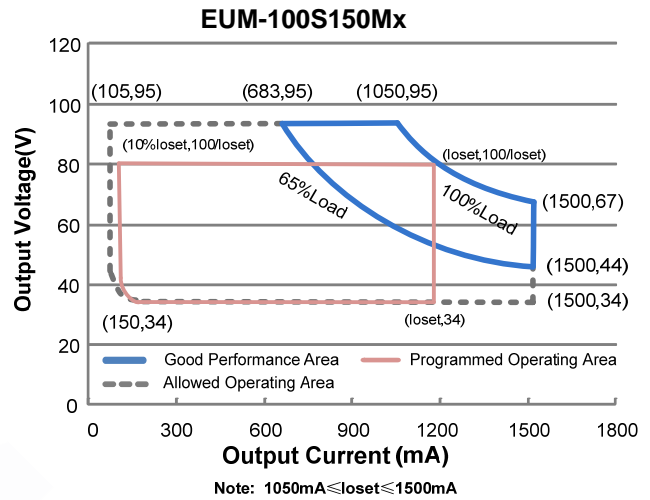
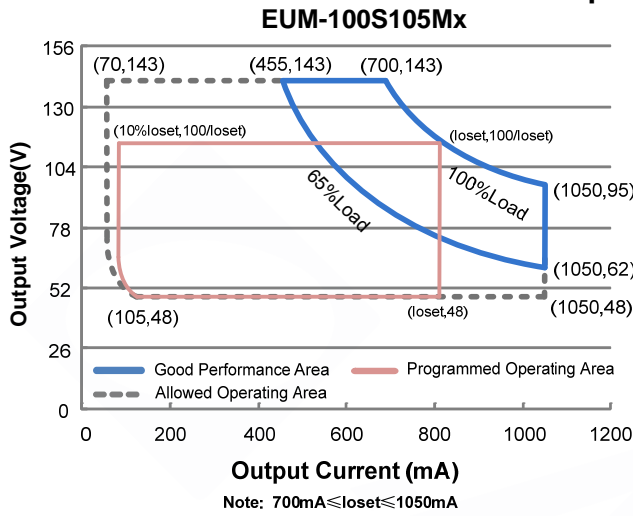

Input Specifications

| Parameter | Min. | Typ. | Max. | Notes |
|----------------------------------|---------|------|-----------------------|--|
| Input AC Voltage | 90 Vac | - | 305 Vac | |
| Input DC Voltage | 127 Vdc | - | 300 Vdc | |
| Input Frequency | 47 Hz | - | 63 Hz | |
| Leakage Current | - | - | 0.75 MIU | UL8750; 277Vac/ 60Hz |
| | - | - | 0.70 mA | IEC60598-1; 240Vac/ 60Hz, |
| Input AC Current | - | - | 1.02 A | Measured at 100% load and 120 Vac input. |
| | - | - | 0.54 A | Measured at 100% load and 220 Vac input. |
| Inrush Current(I ² t) | - | - | 3.45 A ² s | At 220Vac input, 25°C cold start, duration=314 μs, 10%I _{pk} -10%I _{pk} . See Inrush Current Waveform for the details. |

Input Specifications (Continued)

| Parameter | Min. | Typ. | Max. | Notes |
|-----------|------|------|------|---|
| PF | 0.9 | - | - | At 100-277Vac, 50-60Hz, 65%-100% load (65-100W) |
| THD | - | - | 20% | |
| THD | - | - | 10% | At 220-240Vac, 50-60Hz, 75%-100% load (75-100W) |

Output Specifications

| Parameter | Min. | Typ. | Max. | Notes |
|--|----------|----------|----------|--|
| Output Current Tolerance | -5%loset | - | 5%loset | At 100% load condition |
| Output Current Setting(loset) Range | | | | |
| EUM-100S105Mx | 70 mA | - | 1050 mA | |
| EUM-100S150Mx | 105 mA | - | 1500 mA | |
| EUM-100S280Mx | 175 mA | - | 2800 mA | |
| Output Current Setting Range with Constant Power | | | | |
| EUM-100S105Mx | 700 mA | - | 1050 mA | |
| EUM-100S150Mx | 1050 mA | - | 1500 mA | |
| EUM-100S280Mx | 1750 mA | - | 2800 mA | |
| Total Output Current Ripple (pk-pk) | - | 5%lomax | 10%lomax | At 100% load condition. 20 MHz BW |
| Output Current Ripple at < 200 Hz (pk-pk) | - | 2%lomax | - | At 100% load condition. Only this component of ripple is associated with visible flicker. |
| Startup Overshoot Current | - | - | 10%lomax | At 100% load condition |
| No Load Output Voltage | | | | |
| EUM-100S105Mx | - | - | 170 V | |
| EUM-100S150Mx | - | - | 120 V | |
| EUM-100S280Mx | - | - | 60 V | |
| Line Regulation | - | - | ±0.5% | Measured at 100% load |
| Load Regulation | - | - | ±3.0% | |
| Turn-on Delay Time | - | - | 0.5 s | Measured at 120-277Vac input, 65%-100%load |
| Temperature Coefficient of loset | - | 0.03%/°C | - | Case temperature = 0°C ~Tc max |
| 12V Auxiliary Output Voltage | 10.8 V | 12 V | 13.2 V | |
| 12V Auxiliary Output Source Current | 0 mA | - | 250 mA | Return terminal is "Dim" |
| 12V Auxiliary Output Transient Peak Current@6W | - | - | 500 mA | 500mA peak for a maximum duration of 2.2 ms in a 6.0ms period during which time the average should not exceed 250mA. |
| 12V Auxiliary Output Transient Peak Current@10W | - | - | 850 mA | 850mA peak for a maximum duration of 1.3 ms in a 5.2ms period during which time the average should not exceed 250mA. |

General Specifications

| Parameter | Min. | Typ. | Max. | Notes |
|---|--|--|----------------------------|--|
| Efficiency at 120 Vac input: EUM-100S105Mx I _o = 700 mA I _o =1050 mA EUM-100S150Mx I _o =1050 mA I _o =1500 mA EUM-100S280Mx I _o =1750 mA I _o =2800 mA | 87.5% 88.5% 87.5% 88.5% 87.0% 87.0% | 89.5% 90.5% 89.5% 90.5% 89.0% 89.0% | - - - - - - | Measured at 100% load and steady-state temperature in 25°C ambient; (Efficiency will be about 2.0% lower if measured immediately after startup.) |
| Efficiency at 220 Vac input: EUM-100S105Mx I _o = 700 mA I _o =1050 mA EUM-100S150Mx I _o =1050 mA I _o =1500 mA EUM-100S280Mx I _o =1750 mA I _o =2800 mA | 89.5% 90.5% 89.5% 90.5% 89.0% 89.0% | 91.5% 92.5% 91.5% 92.5% 91.0% 91.0% | - - - - - - | Measured at 100% load and steady-state temperature in 25°C ambient; (Efficiency will be about 2.0% lower if measured immediately after startup.) |
| Efficiency at 277 Vac input: EUM-100S105Mx I _o = 700 mA I _o =1050 mA EUM-100S150Mx I _o =1050 mA I _o =1500 mA EUM-100S280Mx I _o =1750 mA I _o =2800 mA | 90.0% 91.0% 90.0% 90.5% 89.0% 89.5% | 92.0% 93.0% 92.0% 92.5% 91.0% 91.5% | - - - - - - | Measured at 100% load and steady-state temperature in 25°C ambient; (Efficiency will be about 2.0% lower if measured immediately after startup.) |
| Standby Power | - | - | 0.5 W | Measured at 230Vac/50Hz; Dimming off |
| MTBF | - | 262,000 Hours | - | Measured at 220Vac input, 80%load and 25°C ambient temperature (MIL-HDBK-217F) |
| Lifetime | - | 112,000 Hours | - | Measured at 220Vac input, 80%load and 70°C case temperature; See lifetime vs. T _c curve for the details |
| Operating Case Temperature for Safety T _{c_s} | -40°C | - | +90°C | |
| Operating Case Temperature for Warranty T _{c_w} | -40°C | - | +80°C | Case temperature for 5 years warranty Humidity: 10% RH to 95% RH; |
| Storage Temperature | -40°C | - | +85°C | Humidity: 5%RH to 95%RH |
| Dimensions Inches (L × W × H) Millimeters (L × W × H) | 5.16 × 2.66 × 1.44 131 × 67.5 × 36.5 | | | With mounting ear 5.83 × 2.66 × 1.44 148 × 67.5 × 36.5 |
| Net Weight | - | 705 g | - | |

Dimming Specifications

| Parameter | | Min. | Typ. | Max. | Notes |
|--|---|---------------------------|-------------|-------------|--|
| Absolute Maximum Voltage on the Vdim (+) Pin | | -20 V | - | 20 V | |
| Source Current on Vdim (+)Pin | | 200 μ A | 300 μ A | 450 μ A | Vdim(+) = 0 V |
| Dimming Output Range | EUM-100S105Mx EUM-100S150Mx EUM-100S280Mx | 10%loset | - | loset | 700 mA \leq loset \leq 1050 mA 1050 mA \leq loset \leq 1500 mA 1750 mA \leq loset \leq 2800 mA |
| | EUM-100S105Mx EUM-100S150Mx EUM-100S280Mx | 70 mA 105 mA 175 mA | - | loset | 70 mA \leq loset < 700 mA 105 mA \leq loset < 1050 mA 175 mA \leq loset < 1750 mA |
| Recommended Dimming Input Range | | 0 V | - | 10 V | Default 0-10V dimming mode. |
| Dim off Voltage | | 0.35 V | 0.5 V | 0.65 V | |
| Dim on Voltage | | 0.55 V | 0.7 V | 0.85 V | |
| Hysteresis | | - | 0.2 V | - | |
| PWM_in High Level | | 3 V | - | 10 V | Dimming mode set to PWM in PC interface. |
| PWM_in Low Level | | -0.3 V | - | 0.6 V | |
| PWM_in Frequency Range | | 200 Hz | - | 3 KHz | |
| PWM_in Duty Cycle | | 1% | - | 99% | |
| PWM Dimming off (Positive Logic) | | 3% | 5% | 8% | |
| PWM Dimming on (Positive Logic) | | 5% | 7% | 10% | |
| PWM Dimming off (Negative Logic) | | 92% | 95% | 97% | |
| PWM Dimming on (Negative Logic) | | 90% | 93% | 95% | |
| Hysteresis | | - | 2% | - | |

Safety & EMC Compliance

| Safety Category | Standard |
|-----------------|---------------------------------|
| UL/CUL | UL8750,CAN/CSA-C22.2 No. 250.13 |
| ENEC & CE | EN 61347-1, EN61347-2-13 |
| CB | IEC 61347-1, IEC 61347-2-13 |
| CCC | GB 19510.1, GB 19510.14 |
| PSE | J 61347-1, J 61347-2-13 |
| KS | KS C 7655 |

Safety & EMC Compliance (Continued)

| EMI Standards | Notes |
|--|---|
| EN 55015/GB 17743/KN 15 ⁽¹⁾ | Conducted emission Test & Radiated emission Test |
| EN 61000-3-2/GB 17625.1 | Harmonic current emissions |
| EN 61000-3-3 | Voltage fluctuations & flicker |
| FCC Part 15 ⁽¹⁾ | ANSI C63.4 Class B |
| | This device complies with Part 15 of the FCC Rules. Operation is subject to the following two conditions: [1] this device may not cause harmful interference, and [2] this device must accept any interference received, including interference that may cause undesired operation. |
| EMS Standards | Notes |
| EN 61000-4-2 | Electrostatic Discharge (ESD): 8 kV air discharge, 4 kV contact discharge |
| EN 61000-4-3 | Radio-Frequency Electromagnetic Field Susceptibility Test-RS |
| EN 61000-4-4 | Electrical Fast Transient / Burst-EFT |
| EN 61000-4-5 | Surge Immunity Test: AC Power Line: Differential Mode 6 kV, Common Mode 10 kV |
| EN 61000-4-6 | Conducted Radio Frequency Disturbances Test-CS |
| EN 61000-4-8 | Power Frequency Magnetic Field Test |
| EN 61000-4-11 | Voltage Dips |
| EN 61547 | Electromagnetic Immunity Requirements Applies To Lighting Equipment |

Note: (1) This LED driver meets the EMI specifications above, but EMI performance of a luminaire that contains it depends also on the other devices connected to the driver and on the fixture itself.

Derating

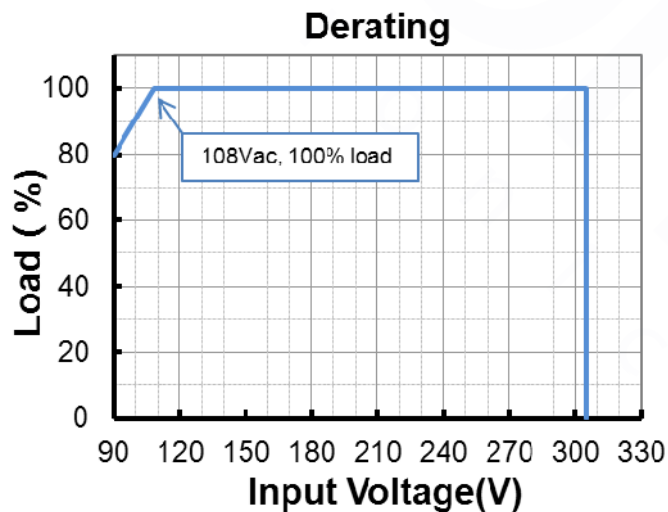

Lifetime vs. Case Temperature

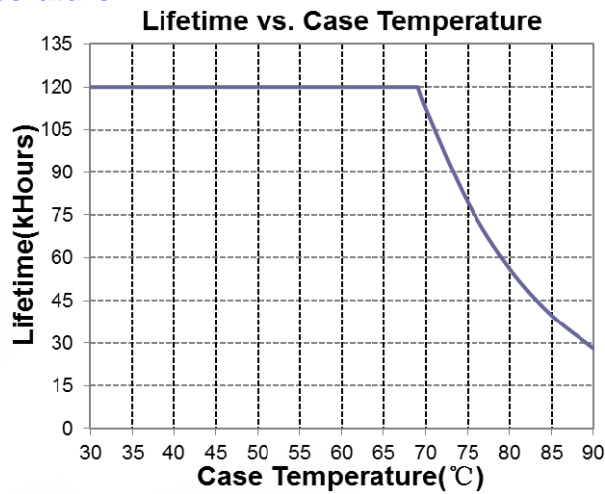

Inrush Current Waveform

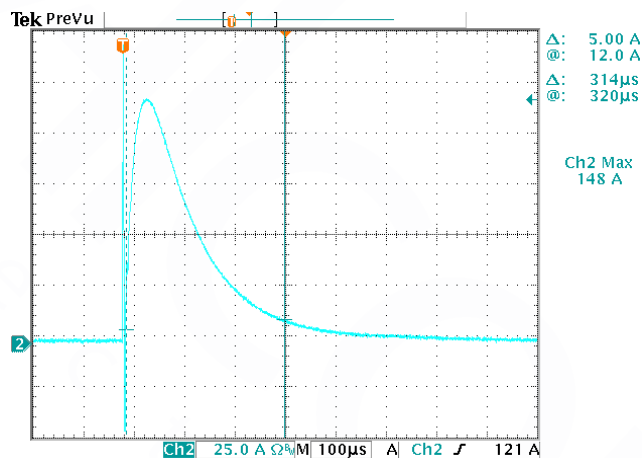

Efficiency vs. Load

EUM-100S105Mx (Io=700mA)
Efficiency vs. Output Voltage

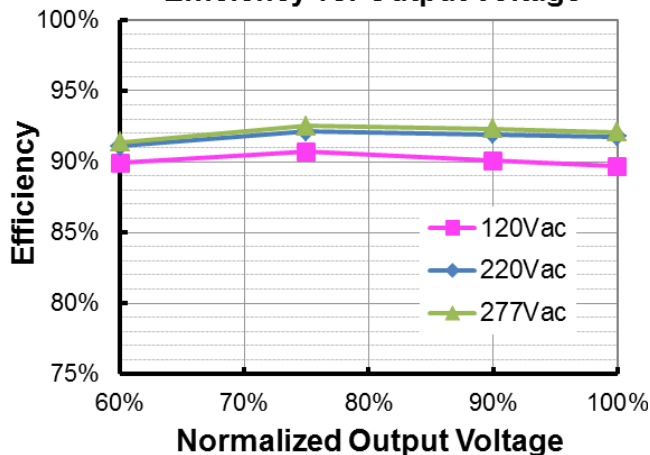

EUM-100S105Mx (Io=1050mA)
Efficiency vs. Output Voltage

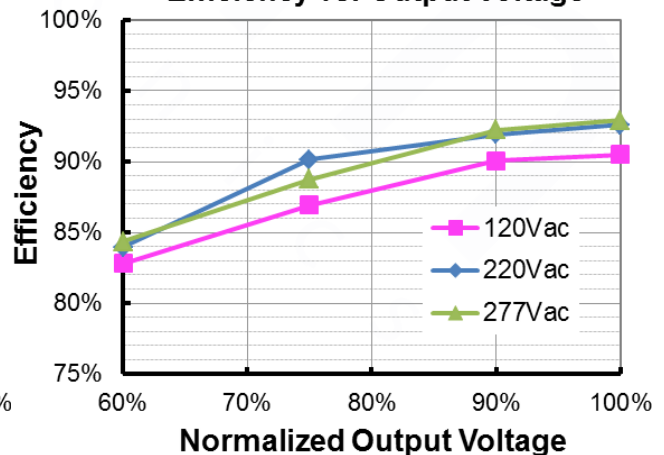

EUM-100S150Mx($I_o=1050mA$)
Efficiency vs. Output Voltage

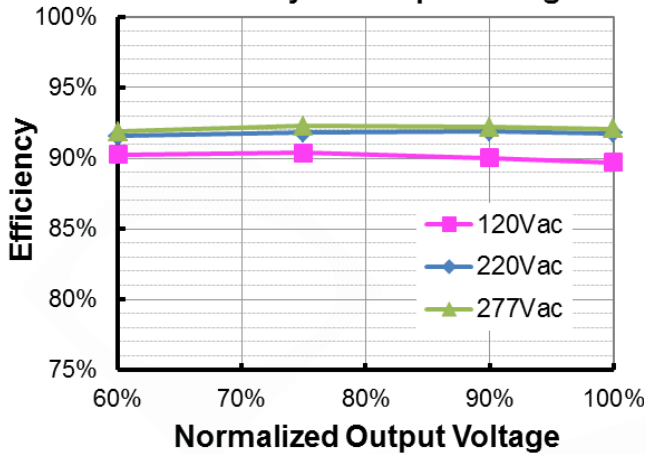

EUM-100S150Mx($I_o=1500mA$)
Efficiency vs. Output Voltage

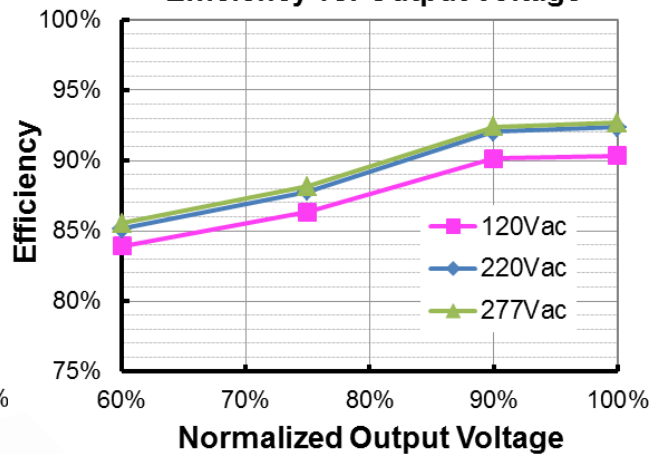

EUM-100S280Mx($I_o=1750mA$)
Efficiency vs. Output Voltage

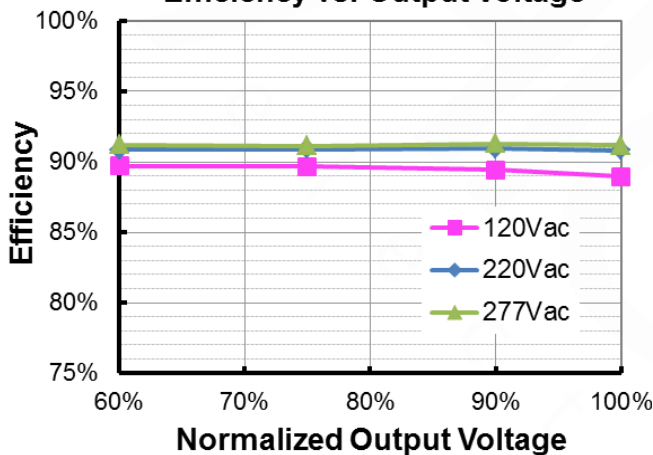

EUM-100S280Mx($I_o=2800mA$)
Efficiency vs. Output Voltage

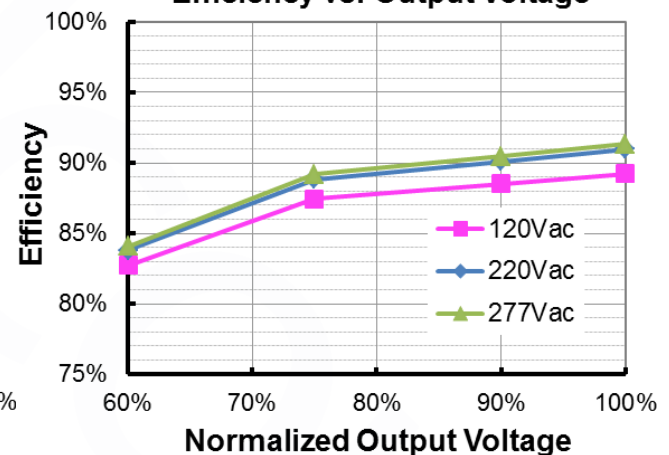

Power Factor

PF vs. Load

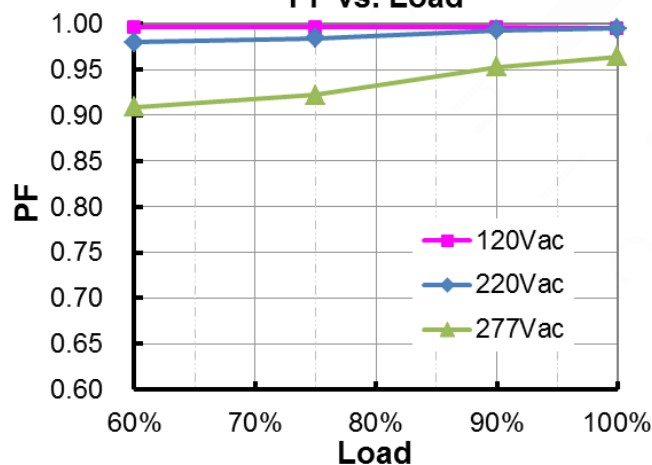

Total Harmonic Distortion

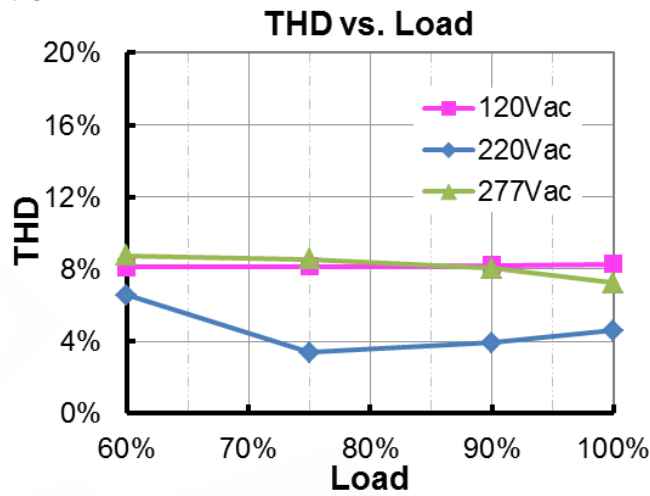

Protection Functions

| Parameter | | Min. | Typ. | Max. | Notes |
|---------------------------------------|--------------------------------|--|---------|---------|--|
| Over Voltage Protection | | Limits output voltage at no load and in case the normal voltage limit fails. | | | |
| Short Circuit Protection | | Auto Recovery. No damage will occur when any output is short circuited. The output shall return to normal when the fault condition is removed. | | | |
| Over Temperature Protection | | Decreases output current, returning to normal after over temperature is removed. | | | |
| Input Under Voltage Protection (IUVP) | Input Under Voltage Protection | 70 Vac | 80 Vac | 90 Vac | Turn off the output when the input voltage falls below protection voltage. |
| | Input Under Voltage Recovery | 75 Vac | 85 Vac | 95 Vac | Auto Recovery. The driver will restart when the input voltage exceeds recovery voltage. |
| Input Over Voltage Protection (IOVP) | Input Over Voltage Protection | 310 Vac | 320 Vac | 330 Vac | Turn off the output when the input voltage exceeds protection voltage. |
| | Input Over Voltage Recovery | 300 Vac | 310 Vac | 320 Vac | Auto Recovery. The driver will restart when the input voltage falls below recovery voltage. |
| | Max. of Input Over Voltage | - | - | 350 Vac | The driver can survive stabilized input over voltage conditions up to 350Vac for a total of 8 hours. |

● **Input Under Voltage Protection Diagram**

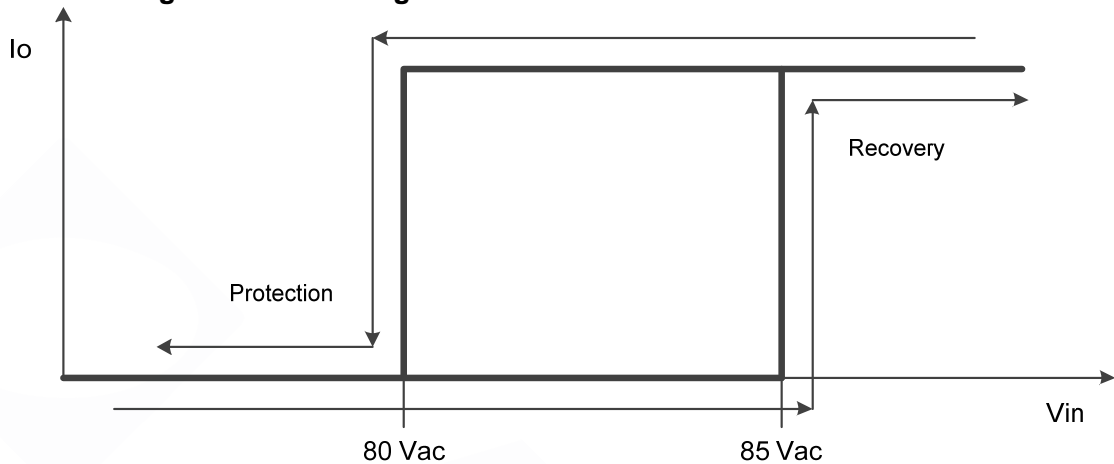

● **Input Over Voltage Protection Diagram**

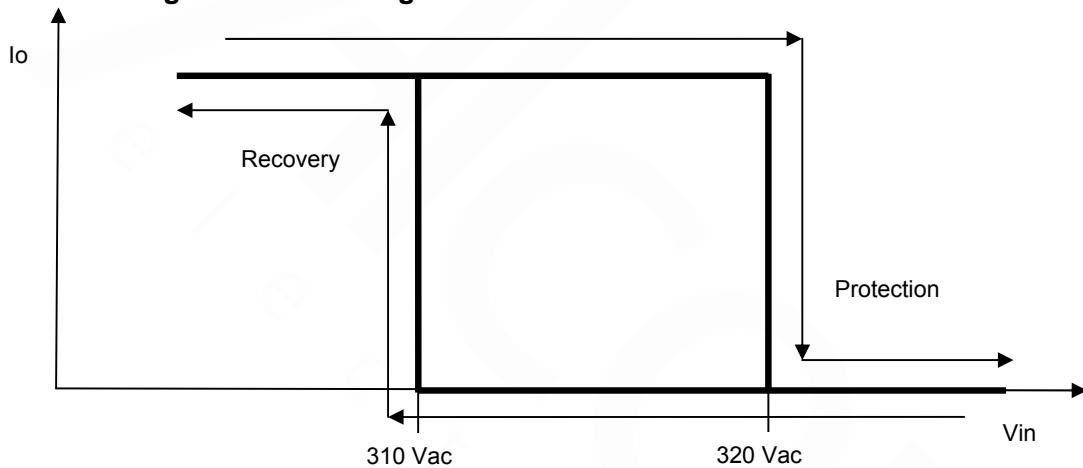

Dimming

● **0-10V Dimming**

The recommended implementation of the dimming control is provided below.

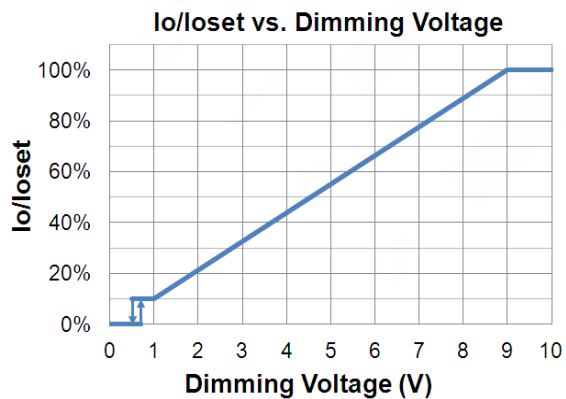
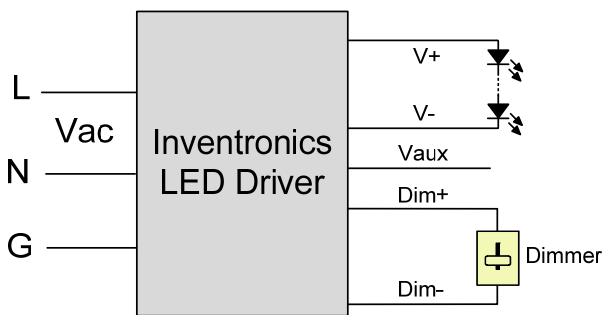

Implementation 1: Positive logic

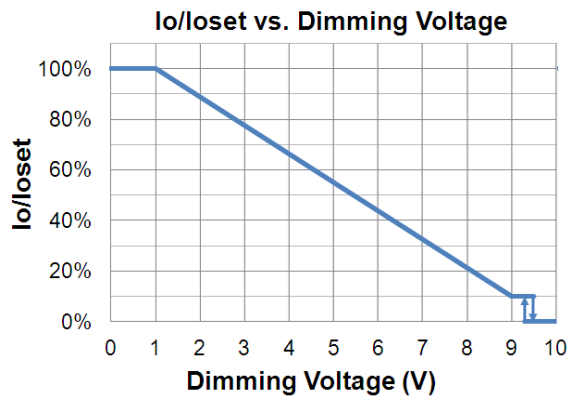
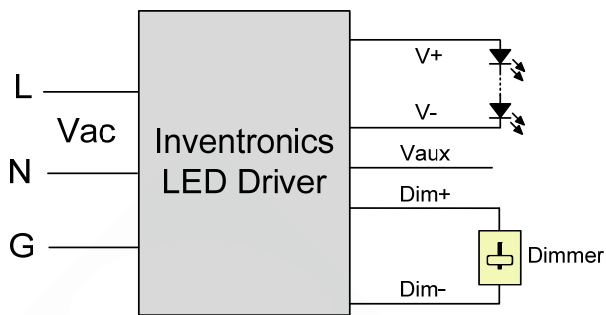

Implementation 2: Negative logic

Notes:

1. Do NOT connect Dim- to the output V- or V+, otherwise the driver will not work properly.
2. The dimmer can also be replaced by an active 0-10V voltage source signal or passive components like zener.
3. When 0-10V negative logic dimming mode and Dim+ is open, the driver will dim to off and be standby..

● **PWM Dimming**

The recommended implementation of the dimming control is provided below.

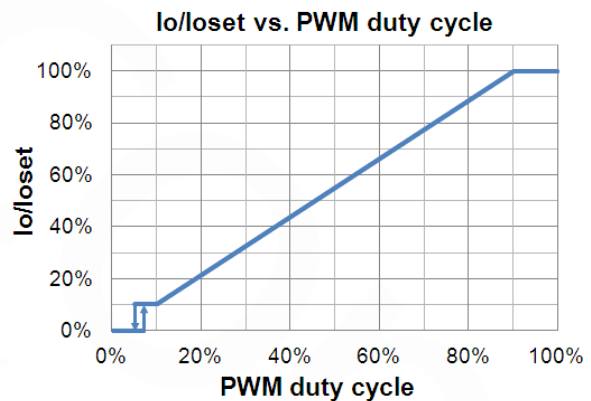
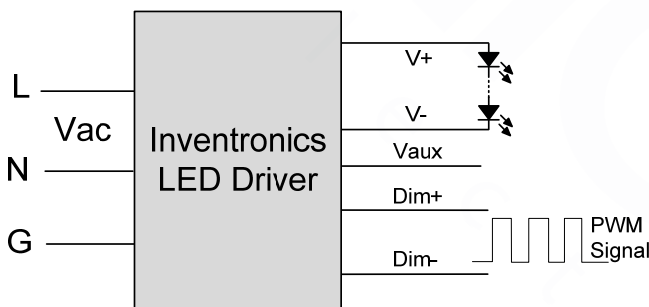

Implementation 3: Positive logic

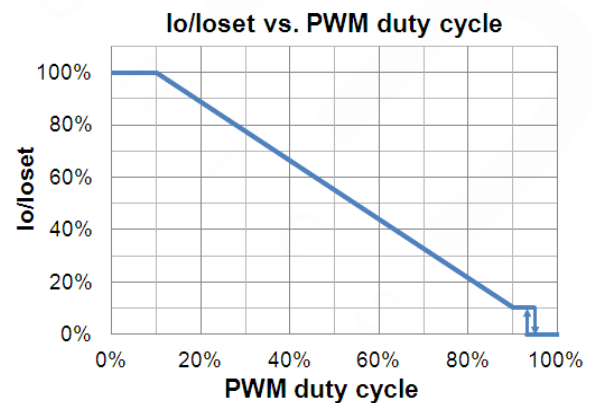
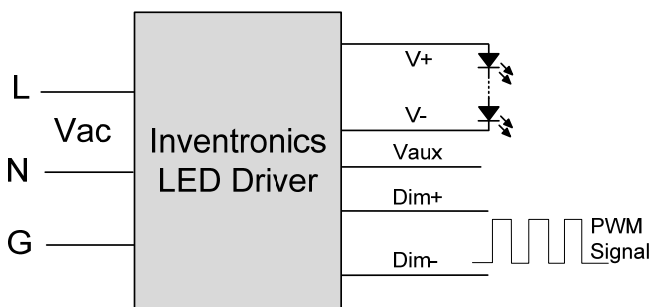

Implementation 4: Negative logic

Notes:

1. Do NOT connect Dim- to the output V- or V+, otherwise the driver will not work properly.
2. When PWM negative logic dimming mode and Dim+ is open, the driver will dim to off and be standby.

● **Time Dimming**

Time dimming control includes 3 kinds of modes, they are Self Adapting-Midnight, Self Adapting-Percentage and Traditional Timer.

- **Self Adapting-Midnight:** Automatically adjusts the dimming curve based on the on-time of past two days (if difference <15 minutes), assuming that the center point of the dimming curve is midnight local time.
- **Self Adapting-Percentage:** Automatically adjusts the on-time of each step by a constant percentage = (actual on-time for the past 2 days if difference <15 min) / (programmed on-time from the dimming curve).
- **Traditional Timer:** Follows the programmed timing curve after power on with no changes.

● **Output Lumen Compensation**

Output Lumen Compensation (OLC) may be used to maintain constant light output over the life of the LEDs by driving them at a reduced current when new, then gradually increasing the drive current over time to counteract LED lumen degradation.

● **End Of Life**

End-of-Life (EOL) is providing a visual notification to a user that the LED module has reached the end of manufacturer-specified life and that the replacement is recommended. Once active, an indication is given at each power-up of the driver, which the driver indicates this through a lower light output during the first 1 minute before normal operation is continued.

● **Digital Dimming**

Inventronics Digital Dimming is a UART (Universal Asynchronous Receive Transmitter) based communication protocol. Please refer to [Inventronics Digital Dimming](#) file for details.

Programming Connection Diagram

EUM-100SxxxMG

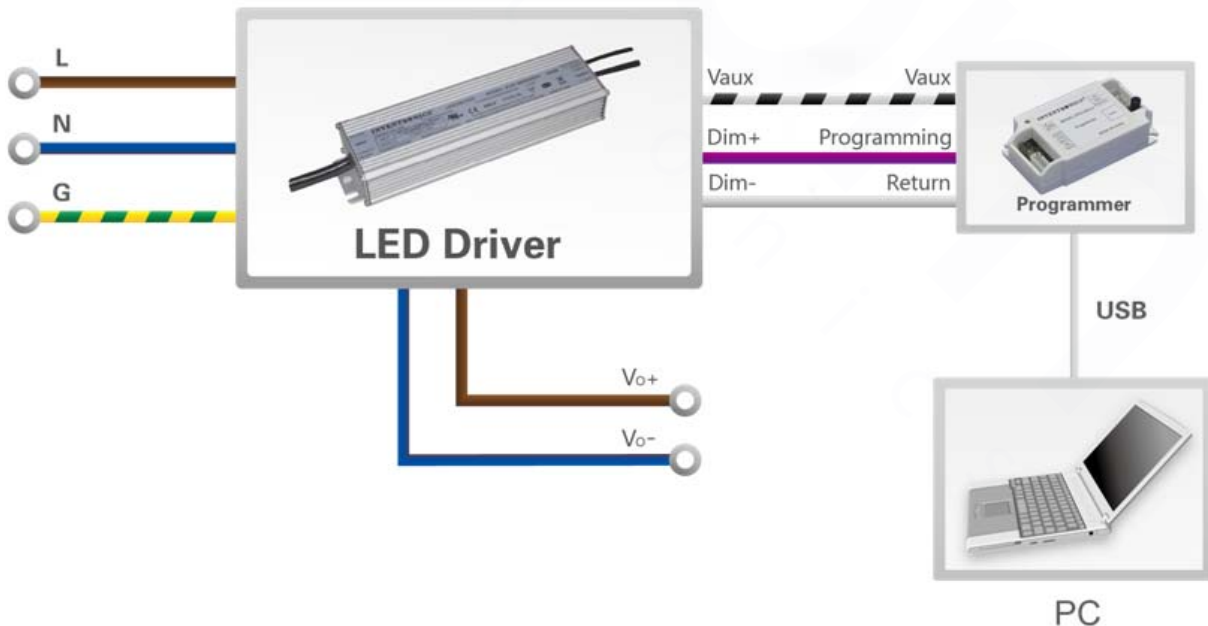

EUM-100SxxxMT

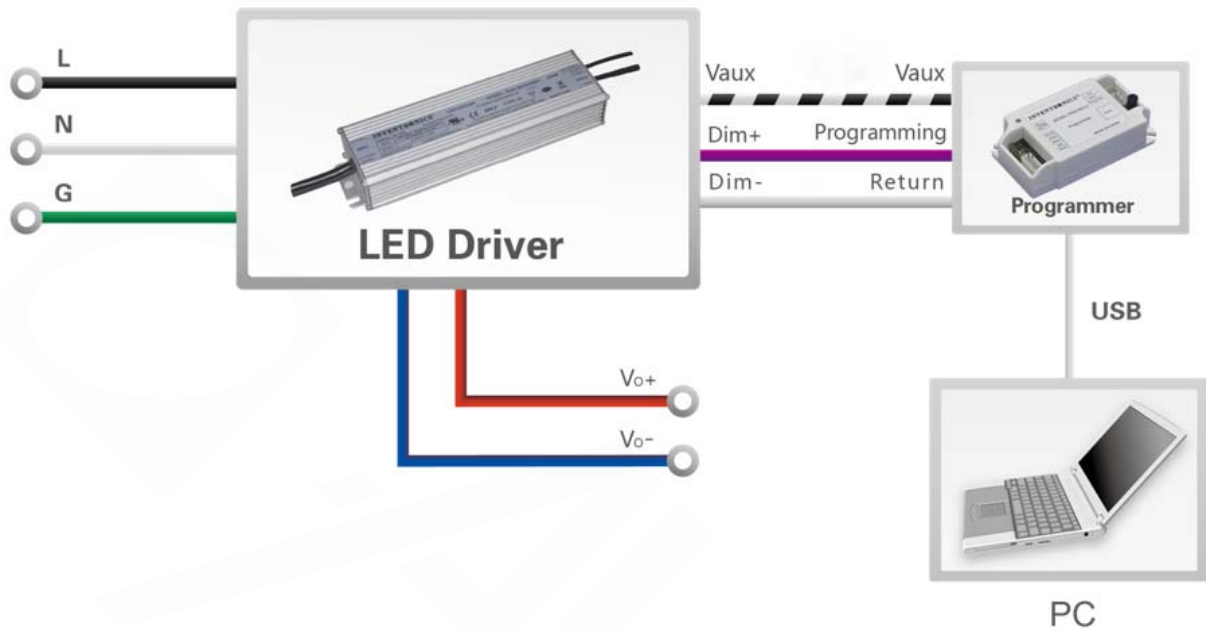

Note: The driver does not need to be powered on during the programming process.

- Please refer to [PRG-MUL2](#) (Programmer) datasheet for details.

Mechanical Outline

EUM-100SxxxMG

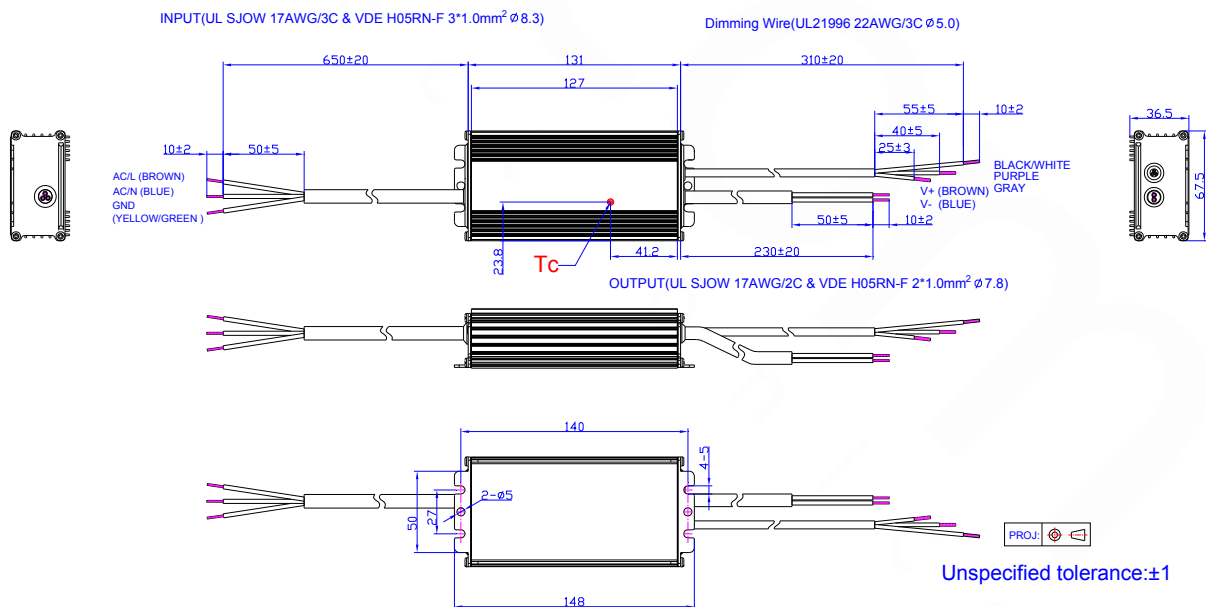

EUM-100SxxxMT

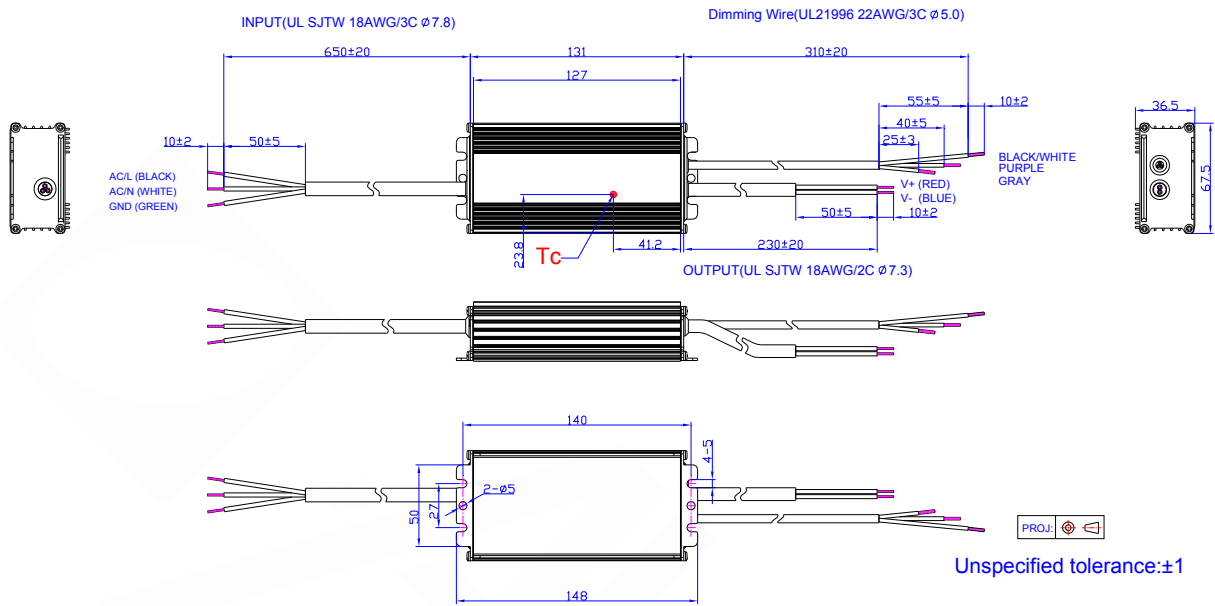

RoHS Compliance

Our products comply with reference to RoHS Directive (EU) 2015/863 amending 2011/65/EU, calling for the elimination of lead and other hazardous substances from electronic products.

Revision History

| Change Date | Rev. | Description of Change | | |
|-------------|------|-----------------------|------|----|
| | | Item | From | To |
| 2020-12-07 | A | Datasheet Release | / | / |

