

## 1 Scope

This specification applies to the HDCI series of multilayer chip ceramic inductors.

## 2 Product Identification

HDCI    1005    T    12N    J    T - LF  
 ①        ②        ③        ④        ⑤        ⑥        ⑦

- ① Product Symbol
- ② Dimensions ( 3 )
- ③ Material Code (HT)
- ④ Inductance Value(12N: 12nH)
- ⑤ Inductance Tolerance(C:±0.2nH;S:±0.3nH;D:±0.5nH;G:±2%;J:±5%;K:±10%;)
- ⑥ Packaging Style (B: Bulk; T: Tape & Reel)
- ⑦ Lead Free

## 3 Appearance, Dimensions and Material

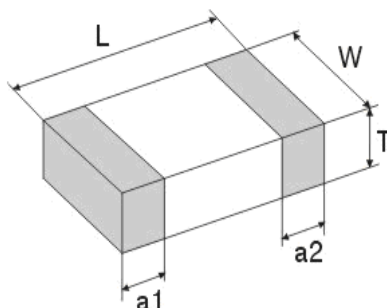

Type	Dimensions (mm) [inch]			
	L	W	T	a1, a2
1005 [0402]	1.00±0.15 [0.04±0.006]	0.50±0.15 [0.02±0.006]	0.50±0.15 [0.02±0.006]	0.25±0.10 [0.01±0.004]

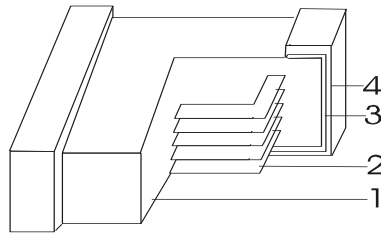

	Composition	Material	Supplier
1	Base Material	Ceramic Material	Japan
2	Internal Conductor	Ag	Japan
3	Terminal Electrode	Ag	Japan
4	Terminal Electrode	Ni-Sn	USA

#### 4 Testing Conditions

<Unless otherwise specified>

Temperature : Ordinary Temperature ( 5 to 35 °C)

Humidity : Ordinary Humidity(25 to 85% RH)

Atmospheric Pressure : 86 to 106 kPa

<In case of doubt>

Temperature : 20±2 °C

Humidity : 60 to 75% RH

Atmospheric Pressure : 86 to 106 kPa

#### 5 Rating

Operating Temperature Range : -55 to +125 °C

Storage Temperature Range : -55 to +125 °C



CUST Part No.	HD Part No.	L (nH)	Tolerance nH or%	L,Q Test Freq. (MHz)	Q 100 MHz min	Q 900 MHz min	Q 1800 MHz min	MHz	Rdc (MAX) (Ω)	Ir(mA) (max)
	HDCI1005T1N0ST-LF	1.0	±0.3nH	100	9	44	50	10000	0.08	400
	HDCI1005T1N2ST-LF	1.2	±0.3nH	100	9	44	50	10000	0.08	400
	HDCI1005T1N5ST-LF	1.5	±0.3nH	100	9	43	48	6000	0.10	400
	HDCI1005T1N6ST-LF	1.6	±0.3nH	100	9	43	48	6000	0.10	400
	HDCI1005T1N8ST-LF	1.8	±0.3nH	100	9	35	45	6000	0.12	400
	HDCI1005T2N0ST-LF	2.0	±0.3nH	100	9	30	43	6000	0.12	400
	HDCI1005T2N2ST-LF	2.2	±0.3nH	100	9	30	43	6000	0.12	400
	HDCI1005T2N4ST-LF	2.4	±0.3nH	100	9	30	43	6000	0.12	400
	HDCI1005T2N7ST-LF	2.7	±0.3nH	100	9	30	40	6000	0.13	400
	HDCI1005T3N0ST-LF	3.0	±0.3nH	100	9	30	40	6000	0.15	400
	HDCI1005T3N3ST-LF	3.3	±0.3nH	100	9	30	40	6000	0.15	400
	HDCI1005T3N6ST-LF	3.6	±0.3nH	100	9	30	41	4500	0.21	400
	HDCI1005T3N9ST-LF	3.9	±0.3nH	100	9	30	41	4500	0.21	400
	HDCI1005T4N3ST-LF	4.3	±0.3nH	100	9	30	36	4500	0.21	300
	HDCI1005T4N7ST-LF	4.7	±0.3nH	100	9	29	38	4500	0.21	300
	HDCI1005T5N1ST-LF	5.1	±0.3nH	100	9	28	36	4000	0.23	300
	HDCI1005T5N6ST-LF	5.6	±0.3nH	100	9	25	32	4000	0.23	300
	HDCI1005T6N2JT-LF	6.2	±5%	100	9	25	32	4000	0.25	300
	HDCI1005T6N8JT-LF	6.8	±5%	100	9	25	33	4000	0.25	300
	HDCI1005T7N5JT-LF	7.5	±5%	100	9	25	32	3600	0.35	300
	HDCI1005T8N2JT-LF	8.2	±5%	100	9	25	32	3600	0.35	300
	HDCI1005T9N1JT-LF	9.1	±5%	100	9	25	31	3200	0.42	300
	HDCI1005T10NJT-LF	10	±5%	100	9	26	30	3200	0.42	300
	HDCI1005T12NJT-LF	12	±5%	100	9	26	29	2800	0.50	300
	HDCI1005T15NJT-LF	15	±5%	100	9	25	26	2500	0.60	300
	HDCI1005T18NJT-LF	18	±5%	100	9	23	24	2200	0.80	300
	HDCI1005T22NJT-LF	22	±5%	100	9	23	22	1900	0.85	300
	HDCI1005T27NJT-LF	27	±5%	100	9	23		1600	1.00	300
	HDCI1005T33NJT-LF	33	±5%	100	9	22		1300	1.00	200
	HDCI1005T39NJT-LF	39	±5%	100	9	21		1200	1.30	200
	HDCI1005T47NJT-LF	47	±5%	100	9	20		1000	1.50	200
	HDCI1005T56NJT-LF	56	±5%	100	9	17		750	1.80	200
	HDCI1005T68NJT-LF	68	±5%	100	9	15		750	1.95	180
	HDCI1005T82NJT-LF	82	±5%	100	9			600	2.10	150
	HDCI1005TR10JT-LF	100	±5%	100	9			600	2.50	150
	HDCI1005TR12JT-LF	120	±5%	100	9			600	2.80	150
	HDCI1005TR15JT-LF	150	±5%	100	8			550	2.90	150
	HDCI1005TR18JT-LF	180	±5%	100	8			500	3.30	100
	HDCI1005TR22JT-LF	220	±5%	100	8			450	3.70	100
	HDCI1005TR27JT-LF	270	±5%	100	8			400	4.10	50
	HDCI1005TR33JT-LF	330	±5%	50	8			350	6.00	50



5.1 Typical Electrical Characteristics

Inductance Vs. Frequency Characteristics

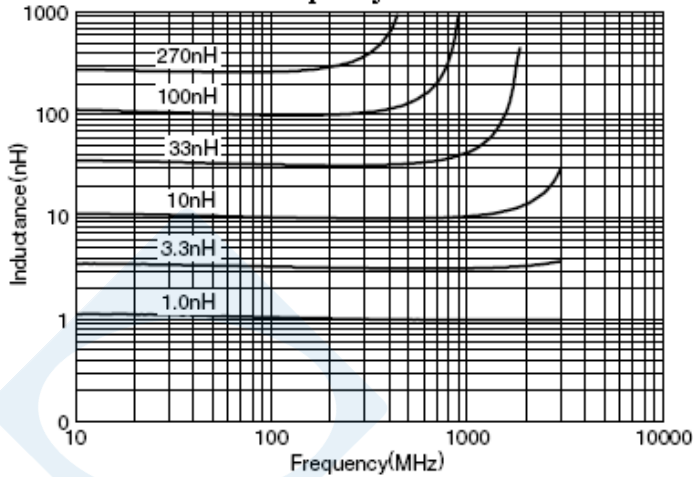

Q Vs. Frequency Characteristics

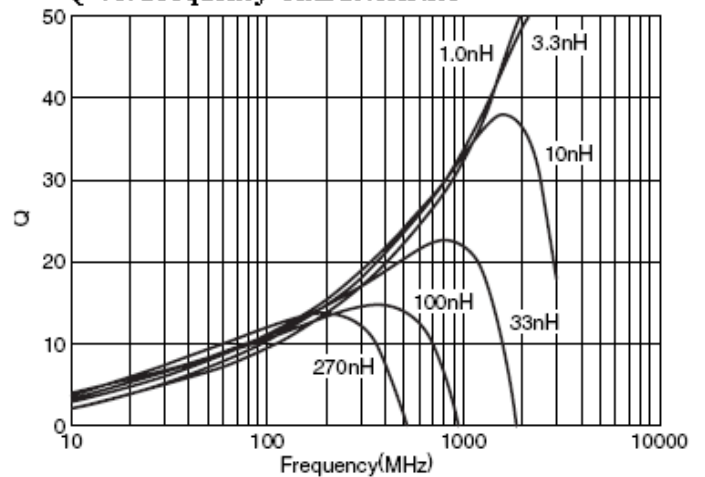

6 Electrical Performance

6.1 Inductance; Q factor

Inductance; Q factor shall meet item 5 when measured on the condition of Table 1.

Table 1

Measuring Equipment	Impedance analyzer HP4291 or equivalent
Measuring Frequency	(see item 5)
Measuring signal level	50mV

6.2 DC Resistance

D.C Resistance shall meet item 5 when measured on the condition of Table 2.

Table 2

Measuring Equipment	LCR HP4263A LCR Meter HP4263A or equivalent
---------------------	--

6.3 Self Resonant Frequency (S.R.F)

S.R.F. shall meet item 5 when measured on the condition of Table 3.

Table 3

Measuring Equipment	Impedance analyzer HP4291, Network analyzer HP8753 or equivalent
---------------------	--

6.4 Rated current

Inductance change shall be within ±5% or temperature rise no more than 20°C against chip surface temperature when the allowable current (which is mentioned in item 5) is applied.

Table 4

Measuring Equipment	DC Power Supplier, Current Meter, Thermometer
---------------------	---

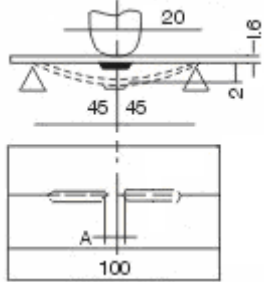
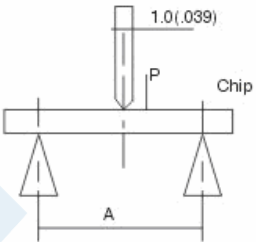
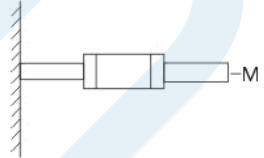

**7 Reliable Performance**

NO.	Item	Specifications	Test Methods						
1	Solder-Ability	More than 90% of termination should be covered with new solder.	Solder: Sn Temperature : 255°C+5°C/-0°C Flux: rosin Duration : 3.5±0.5s						
2	Leaching Resistance	More than 75% of termination Should be covered with new solder.	Solder : Sn Temperature : 270°C+2°C/-0°C Flux: rosin Duration : 10±0.5s						
3	Bending Strength	No mechanical damage should be noticed	When the board curve to 2mm(0.079 inches) <table border="1" data-bbox="906 788 1185 889"> <thead> <tr> <th>Size</th> <th>A(mm)</th> </tr> </thead> <tbody> <tr> <td>1005</td> <td>0.5</td> </tr> </tbody> </table> 	Size	A(mm)	1005	0.5		
Size	A(mm)								
1005	0.5								
4	Body Strength	No mechanical damage should be noticed	Applied specified pull strength in axial direction <table border="1" data-bbox="906 1153 1185 1254"> <thead> <tr> <th>Size</th> <th>A/mm</th> <th>P/N</th> </tr> </thead> <tbody> <tr> <td>1005</td> <td>0.7</td> <td>4.9</td> </tr> </tbody> </table> 	Size	A/mm	P/N	1005	0.7	4.9
Size	A/mm	P/N							
1005	0.7	4.9							
5	Terminal Strength	The terminal and body should be no damage	Applied specified pull strength in axial <table border="1" data-bbox="922 1552 1201 1668"> <thead> <tr> <th>Size</th> <th>Pull Strength</th> <th>Time (s)</th> </tr> </thead> <tbody> <tr> <td>1005</td> <td>5 N</td> <td>5±1</td> </tr> </tbody> </table> 	Size	Pull Strength	Time (s)	1005	5 N	5±1
Size	Pull Strength	Time (s)							
1005	5 N	5±1							



NO.	Item	Specifications	Test Methods
6	Drop		Drop 10 times on a concrete floor from a height of 1m.
7	Vibration		Frequency : 10 to 55Hz Amplitude : 1.52mm Direction and time : X, Y and Z directions for 2 hours each.
8	Humidity resistance		a. Test condition Temp.: 60±2°C Humidity : 90%~95% Test time : 1000 h b. Measurement method : The component should be stabilized at normal condition for 24 hours before test.
9	High temperature resistance	1.No mechanical damage shall be noticed 2. Inductance shall be within: 0.001μH ~ 10μH: ±10% 10μH ~ 220μH: ±20% 3. Q factor shall be within Q : ±30%	a. Test condition Applied rated current Temp. : 125±2°C Test time : 1000 h b. Measurement method : The component should be stabilized at normal condition for 24 hours before test.
10	Low temperature resistance		a. Test condition Temp. : -55±2°C Test time : 1000 h b. Measurement method : The component should be stabilized at normal condition for 24 hours before test.
11	Thermal shock		a. Test condition 1) Temp. : -55°C, time : 30±3min 2) Temp. : +125°C, time : 30±3min 100 cycles b. Measurement method : The component should be stabilized at normal condition for 24 hours before test.



### 8 Recommended Soldering Conditions

Product can be applied to flow and reflow soldering.

(1) Flux, Solder

① Use rosin-based flux. Don't use highly acidic flux with halide content exceeding 0.2wt% (chlorine conversion value).

② Use Sn solder.

(2) Flow soldering conditions

① Pre-heating should be in such a way that the temperature difference between solder and product surface is limited to 150°C max. Cooling into solvent after soldering also should be in such a way that temperature difference is limited to 100°C max. Unwrought pre-heating may cause cracks on the product, resulting in the deterioration of products quality.

② Standard soldering profile.

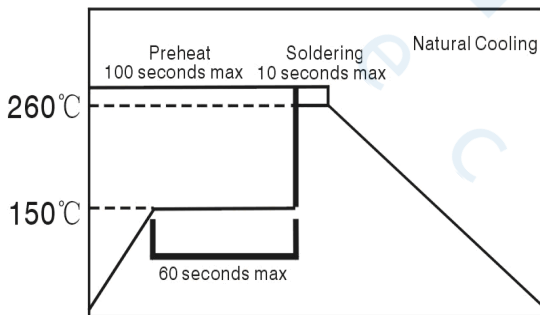

<b>Pre-heating</b>	150°C, 1 minute min
<b>Peak</b>	260°C, 10 seconds max

(3) Reflow soldering conditions

Profile Feature	Lead-Free Assembly
Average Ramp-Up Rate ( T <sub>smax</sub> to T <sub>p</sub> )	3°C /second max.
Preheat - Temperature Min (T <sub>smin</sub> ) - Temperature Max (T <sub>smax</sub> ) - Time ( t <sub>smin</sub> to t <sub>smax</sub> ) min to t <sub>smax</sub> )	150 °C 200 °C 60-180 seconds

Profile Feature	Lead-Free Assembly
Time maintained above: - Temperature (TL) - Time (tL)	217 °C 60-150 seconds
Peak/Classification Temperature (Tp) Peak/Classification Time (Tp)	260 °C 3-4 seconds
Time within 5 °C of actual Peak Temperature (tp)	20-40 seconds
Ramp-Down Rate	6°C/second max.
Time 25 °C to Peak Temperature	8 minutes max.

Note 1: All temperatures refer to topside of the package, measured on the package body surface.

Standard soldering profile

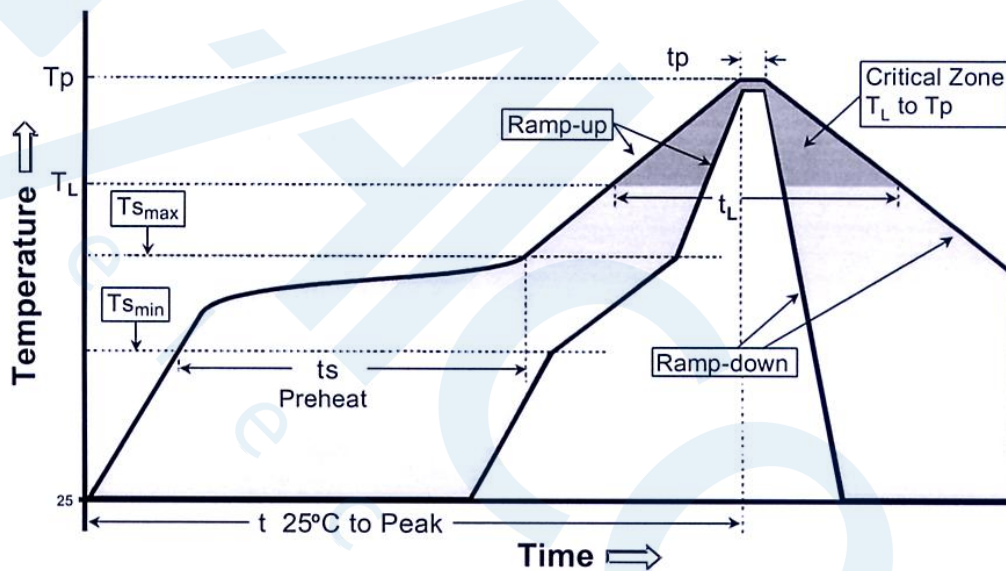

(4) Reworking with soldering iron

The following conditions must be strictly followed when using a soldering iron.

<b>Pre-heating</b>	150°C, 1 minute
<b>Tip temperature</b>	350°C max
<b>Soldering iron output</b>	80w max
<b>End of soldering iron</b>	φ 1mm max
<b>Soldering time</b>	3 seconds max





## 9 Cleaning Conditions

Products shall be cleaned on the following conditions.

(1) Cleaning temperature shall be limited to 60°C max.(40°C max for fluoride and alcohol type cleaner.)

(2) Ultrasonic cleaning shall comply with the following conditions with avoiding the resonance phenomenon at the mounted products and P.C.B.

Power : 20W/t max

Frequency: 40 kHz

Time : 5 minutes max

(3) Cleaner

a) Alternative cleaner

Isopropyl alcohol (IPA)    HCFC-225

b) Aqueous agent

Surface Active Agent Type (CLEANTHROUGH 750H)

Hydrocarbon Type (TECHNOCLEANER 335)

Higher Alcohol Type (PINE ALPHA ST-100S)

Alkali Saponification Type (\*AQUACLEANER 240)

(4) There shall be no residual flux and residual cleaner after cleaning. In the case of using aqueous agent, products shall be dried completely after rinse with de-ionized water in order to remove the cleaner.

(5) Other cleaning Please contact us.

## 10 Packaging

### (1) Dimensions of Tape:

Paper / Embossed carrier tape:

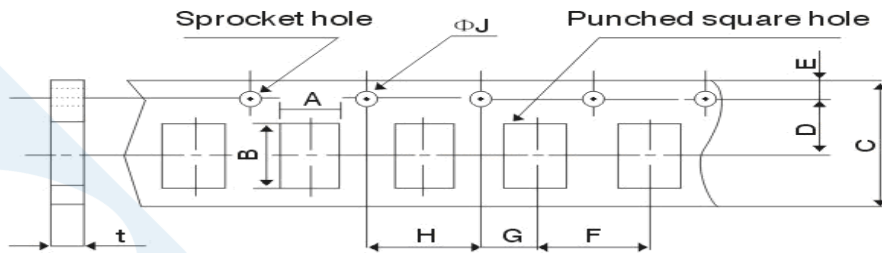

Type	1005
T*	0.5±0.15
	Paper carrier tape
A	0.65±0.10
B	1.15±0.10
C	8.0±0.3
D	3.5±0.05
E	1.75±0.1
F	2.0±0.05
G	2.0±0.05
H	4.0±0.1
ΦJ	1.5+0.1/-0
t(max)	0.8±0.05

T\*: Product thickness

### (2) Dimensions of Reel

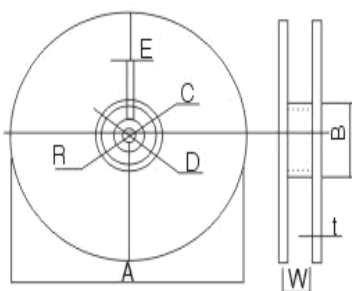

Reel material: PS (Polystyrene)

Unit: mm

<b>A</b>	178±2
<b>B</b>	60±2
<b>C</b>	13.0±0.5
<b>D</b>	21.0±0.8
<b>E</b>	2.0±0.5
<b>W</b>	10.0±1.15
<b>t</b>	1.2±0.2
<b>R</b>	1.0±0.25

(3) Pulling strength of tapes

<b>Carrier tape</b>	10N or more (1kgf or more)
<b>Cover tape</b>	5N or more (0.5kgf or more)

(4) Taping figure and drawing direction

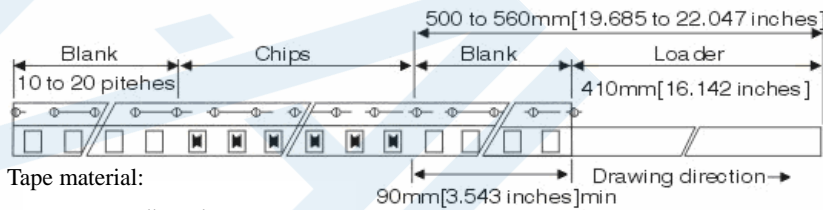
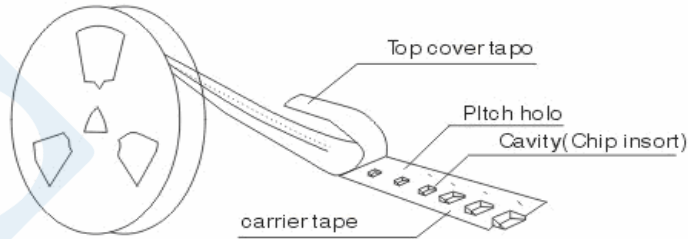

Tape material:  
Base tape: cardboard  
Cover tape: polyethylene

(5) Peeling strength of cover tape

<b>Cover tape</b>	0.3~0.7N (30gf~70gf)
-------------------	----------------------

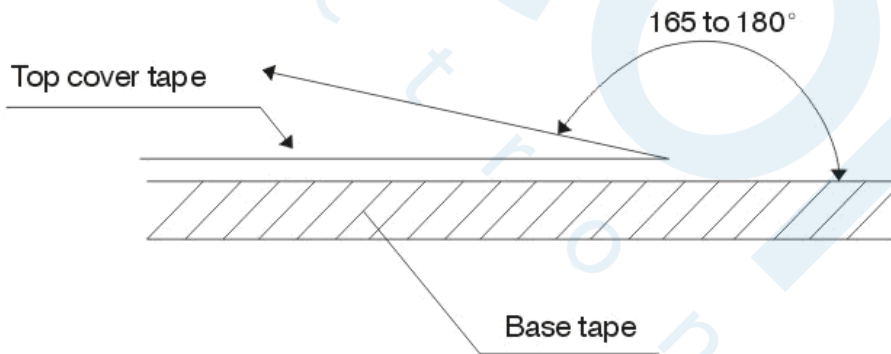

Test condition:

- 1) peel angle: 165°~180° vs. carrier tape.
- 2) peel speed: 300 mm/min±10%.

(6) Box and case dimensions

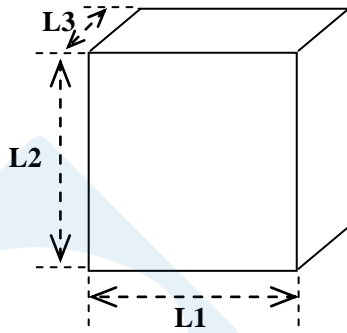

Unit: mm

Type	L1	L2	L3
Box	180±2	180±2	75±1
Box	180±2	180±2	120±2
Case	400±2	400±2	200±2

A 6 reels in a box.

B 10 boxes in a case.

(7) Packaging quantities

Type	Thickness(mm)	Bulk	Tape and reel
1005	0.5±0.15	----	10000pcs

**11 Storage**

(1) Storage period

Products which inspected in over 6 months ago should be examined and used, which can be confirmed with inspection No. marked on the container. Solder ability should be checked if this period is exceeded.

(2) Storage conditions

① Products should be storage in the warehouse on the following conditions

Temperature:  $\cong 40^{\circ}\text{C}$

Humidity :  $\cong 70\%$  relative humidity

No rapid change on temperature and humidity

② Don't keep products in corrosive gases such as sulfur, chlorine gas or acid, or it may cause oxidization of electrode, resulting in poor solder ability.

③ Products should be storage on the palette for the prevention of the influence from humidity, dust and so on.



- ④ Products should be storage in the warehouse without heat shock, vibration, direct sunlight and so on.
- ⑤ Products should be storage under the airtight packaged condition.

## 12 Usage of Nonflammable Material

For these materials listed below, we don't use in process.

Cd, Hg, As and its compound, PCB, etc.

PBBS, PBBOs, PBDO, PBDE, PBB.

## 13 Usage of ODS

For ODS listed below, we don't use in process.

ODS: CCL<sub>4</sub>, HCFC, etc. ODS.

## 14 Flammability Class

UL 94V-1

## 15 Note

- ① This product specification guarantees the quality of our product as a single unit. Please make sure that your product is evaluated and confirmed against your specifications when our product is mounted to your product.
- ② We cannot warrant against failure caused by any use of our product that deviates from the intended use as described in this product specification.
- ③ Please return our copy of this product specification in two month after issued date with your signature of receipt. If the copy is not returned by the date, this product specification will be deemed to have been received.