



Datasheet

All-band High Precision GNSS Stacked Patch Antenna

Part No:
GPDF6010.A

Description:

Passive All-band High Precision GNSS Stacked Patch Antenna

Features:

Bands Covered:

- GPS (L1/L2/L5)
- IRNSS (L5)
- QZSS (L1/L2C/L5/L6)
- Galileo (E1/E5a/E5b/E6)
- GLONASS (G1/G2/G3)
- BeiDou (B1/B2a/B2b/B3)

Dual pin, dual feed, 4-pin configuration

Dimensions: D60 x 10mm

RoHS & Reach Compliant

PATENT PENDING

1. Introduction	3
2. Specifications	4
3. Antenna Characteristics (with hybrid coupler)	6
4. Radiation Patterns	11
5. Mechanical Drawing	19
6. Antenna Integration Guide	20
7. Evaluation Board Matching Circuit	24
8. Packaging	25
<hr/>	
Changelog	26

Taoglas makes no warranties based on the accuracy or completeness of the contents of this document and reserves the right to make changes to specifications and product descriptions at any time without notice. Taoglas reserves all rights to this document and the information contained herein. Reproduction, use or disclosure to third parties without express permission is strictly prohibited.



1. Introduction



The Taoglas **GPDF6010.A** is an innovative high performance, multi-band passive high precision GNSS antenna that has been carefully designed to provide fantastic positional accuracy on the full GNSS spectrum. It covers GPS/QZSS L1/L2/L5/L6, GLONASS G1/G2/G3, Galileo E1/E5a/E5b, BeiDou B1/B2a/B2b/B3, NAVIC L5, as well as SBAS (WAAS/EGNOS/GAGAN/SDCM/SNAS) and L-band corrections.

Correct implementation of the GPDF6010.A allows the user to achieve higher location accuracy, as well as stability of position tracking in urban environments. The novel Terrablast circular stacked patch construction has excellent performance across the full bandwidth of the antenna while reducing weight by nearly 40% compared to other antenna options. Its unique design provides excellent polarization and phase performance, providing exceptional positional and timing accuracy.

Typical applications that benefit from high precision capabilities include:

- Autonomous Driving
- Unmanned Aerial Vehicles
- Precision Positioning for Robotics
- Precision Agriculture
- Timing Accuracy Synchronization

The GPDF6010.A is the latest embedded addition to Taoglas' product portfolio of high precision GNSS antennas. When used on the base and/or the rover as part of an RTK configuration, the GPDF6010.A can achieve genuine cm-level accuracy with proven results.

Full integration guidelines are contained in Section 6 of this datasheet including the Taoglas **HC125.A** hybrid coupler that will be required for use for dual pin feed patch integrations.

Contact your local Taoglas Customer Services team for more information on any of the products listed above or for support regarding integration.

2. Specifications

GNSS Frequency Bands Covered							
GPS	L1	L2	L5				
	■	■	■				
GLONASS	G1	G2	G3				
	■	■	■				
Galileo	E1	E5a	E5b	E6			
	■	■	■	■			
BeiDou	B1	B2a	B2b	B3			
	■	■	■	■			
QZSS (Regional)	L1	L2C	L5	L6			
	■	■	■	■			
IRNSS (Regional)	L5						
	■						
SBAS	L1/E1/B1	L5/B2a/E5a	G1	G2	G3	L-Band	
	■	■	■	■	■	■	

*SBAS systems: WASS(L1/L5), EGNOS(E1/E5a), SDCM(G1/G2/G3), SNAS(B1,B2a), GAGAN(L1/L5), QZSS(L1/L5), KAZZ(L1/L5).

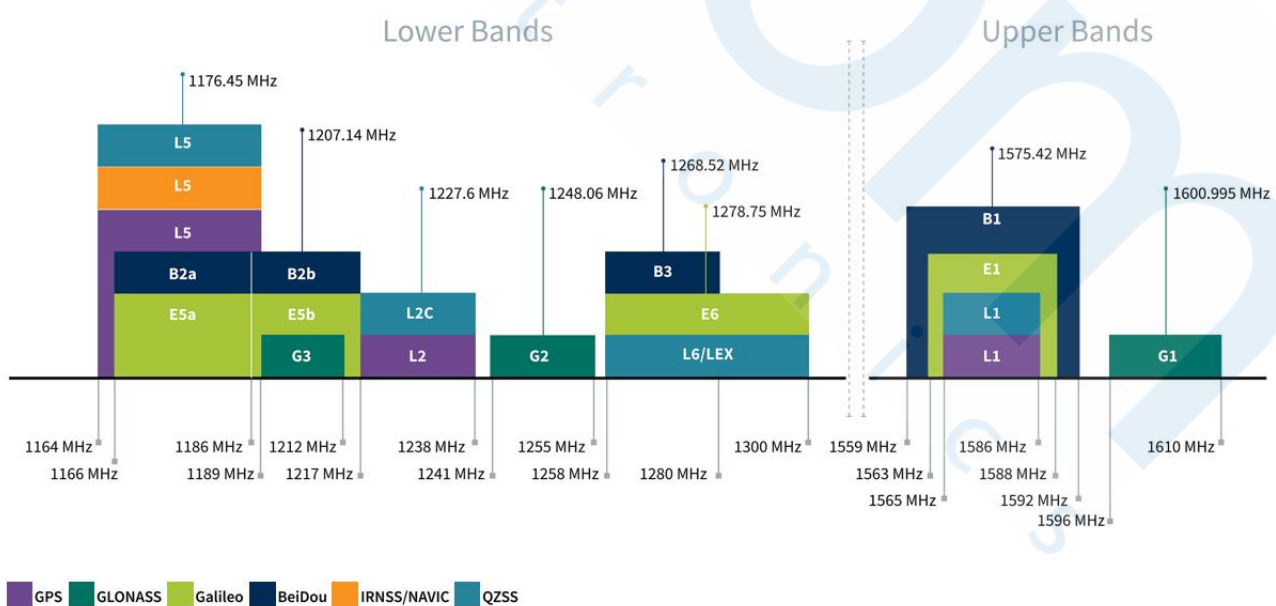

GNSS Bands and Constellations

GNSS Electrical							
Frequency (MHz)	1176.45	1227.6	1278	1525	1561	1575.42	1602
VSWR (max.)	1.5:1	1.5:1	1.5:1	1.5:1	1.5:1	1.5:1	1.5:1
Passive Antenna Efficiency (%)	20	40	20	38	53	50	38
Passive Antenna Gain at Zenith (dBic)	-1.5	1.8	-1.5	2.6	4.2	4.0	2.7
Axial Ratio (dB)	< 1.5	< 1	< 1	< 2	< 1.5	< 1	< 1
Group Delay (ns)	5.0	3.7	4.6	3.5	4.0	4.4	4.7
PCO (cm)	1.3	1.1	0.7	1.2	1.0	1.0	1.0
PCV (cm)	0.6	0.3	0.5	0.4	0.3	0.3	0.3
Polarization	RHCP						
Impedance	50Ω						

Note: The antenna with Hybrid couplers and matching circuit was tested on a 100 mm-diameter ground plane
The PCO and PCV are calculated using a field of view of 60° elevation from zenith

Mechanical	
Height	10 mm
Planner Dimension	60 mm diameter
Weight	45 g
Environmental	
Temperature Range	-40°C to 85°C
RoHS Compliant	Yes
REACH Compliant	Yes

3. Antenna Characteristics(with hybrid coupler)

3.1 Return Loss

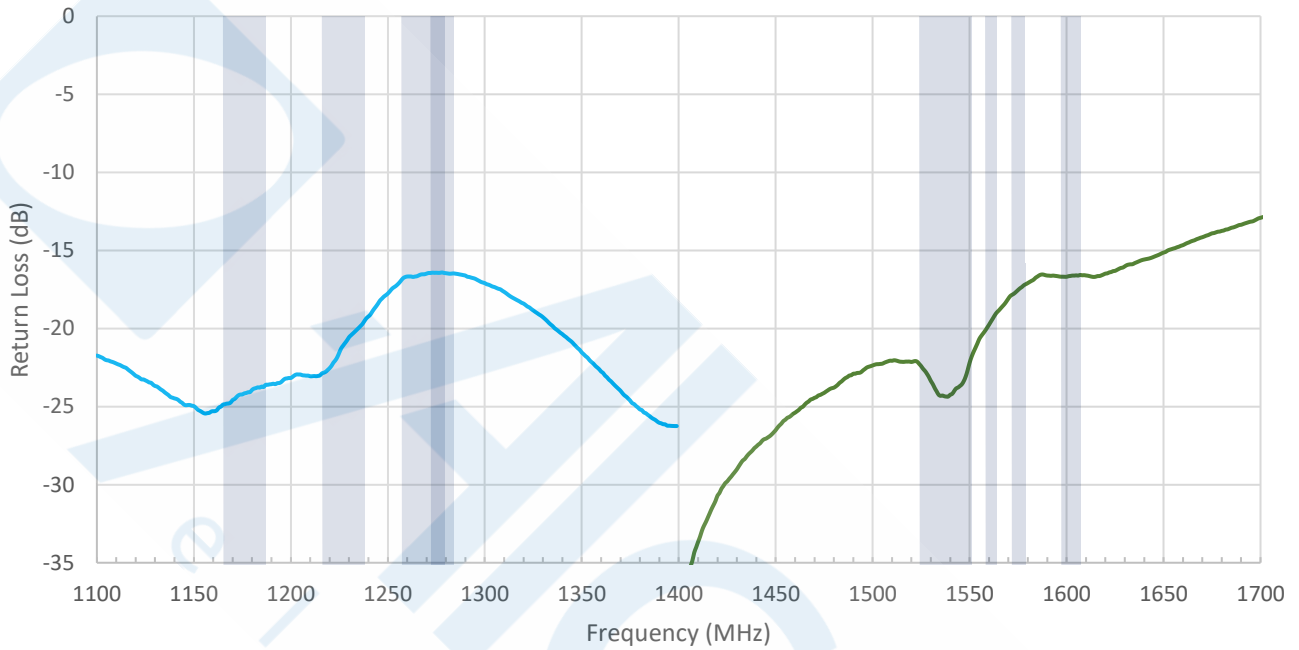

3.2 Efficiency

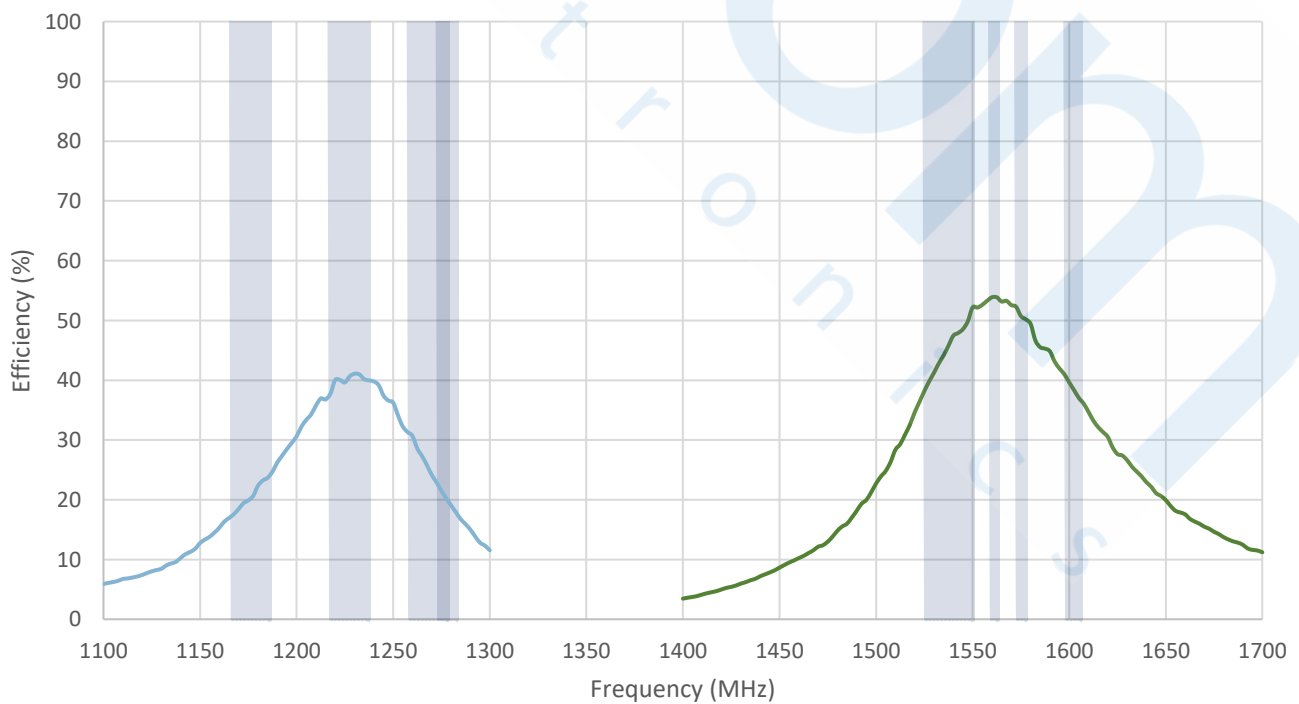

3.3 Average Gain

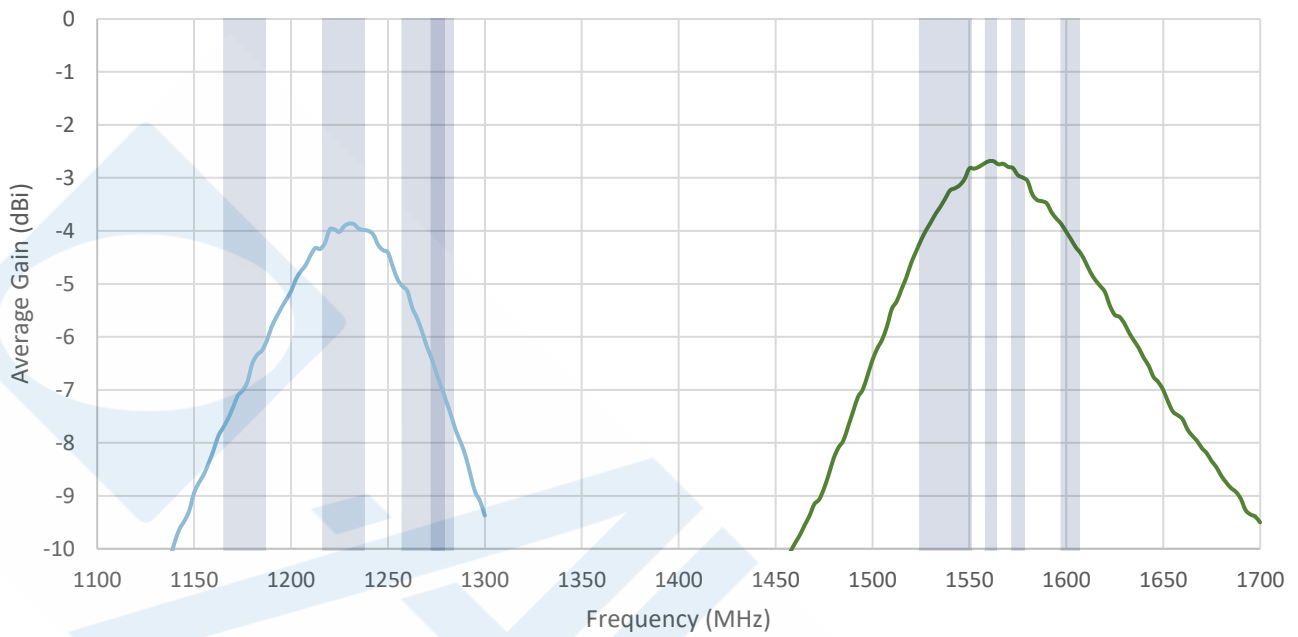

3.4 Peak Gain

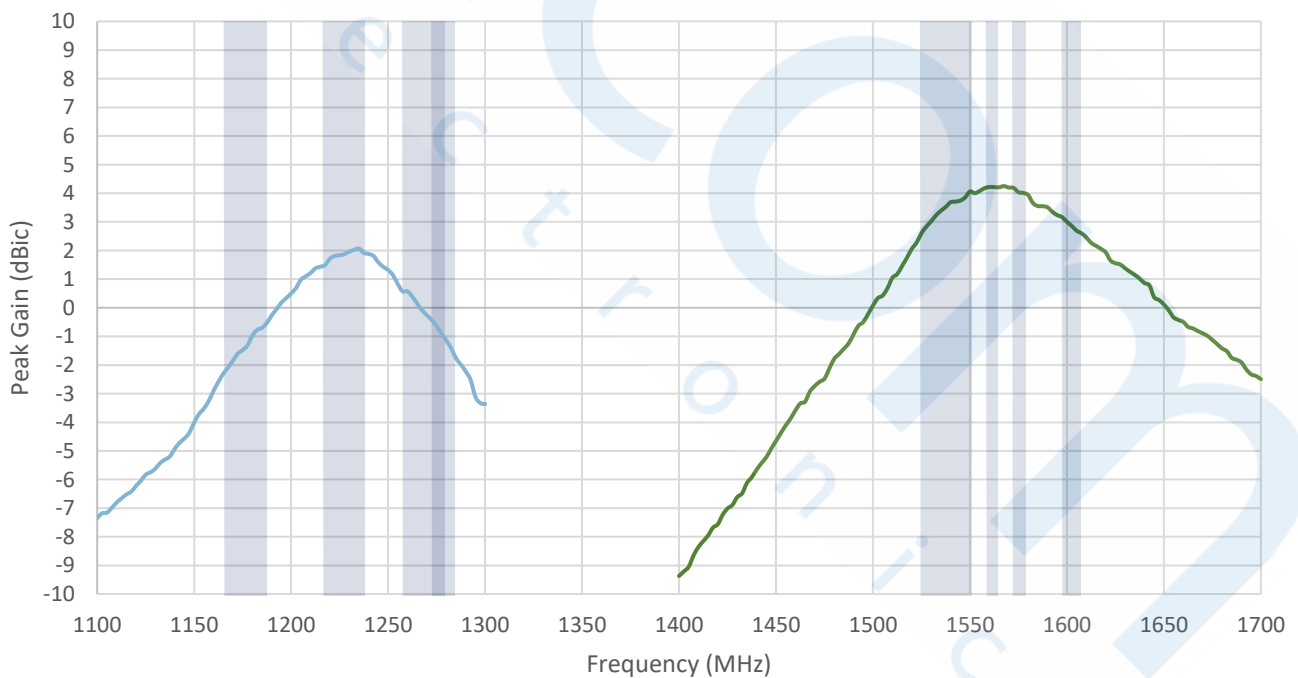

3.5 Axial Ratio

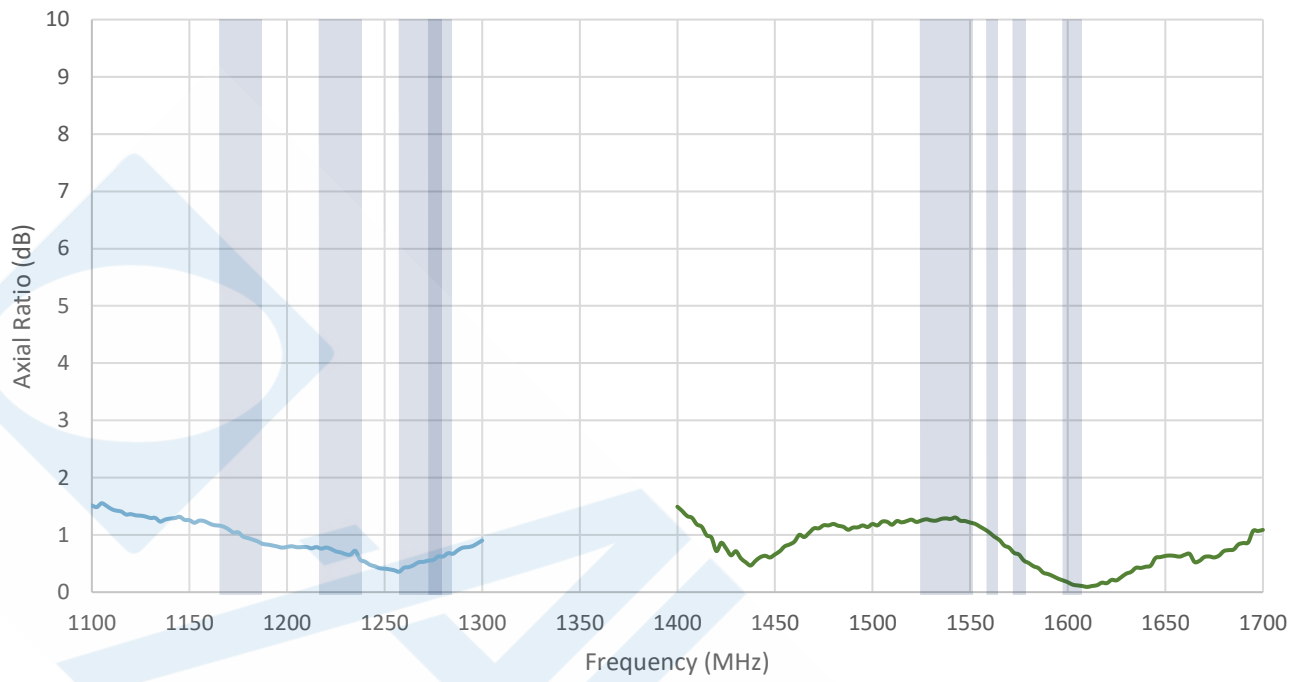

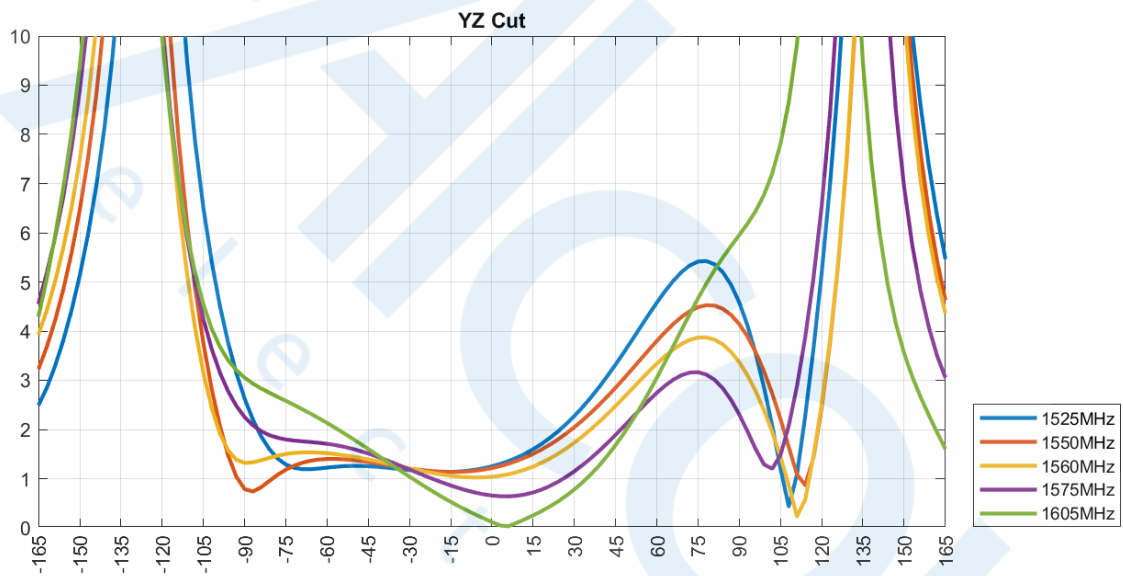
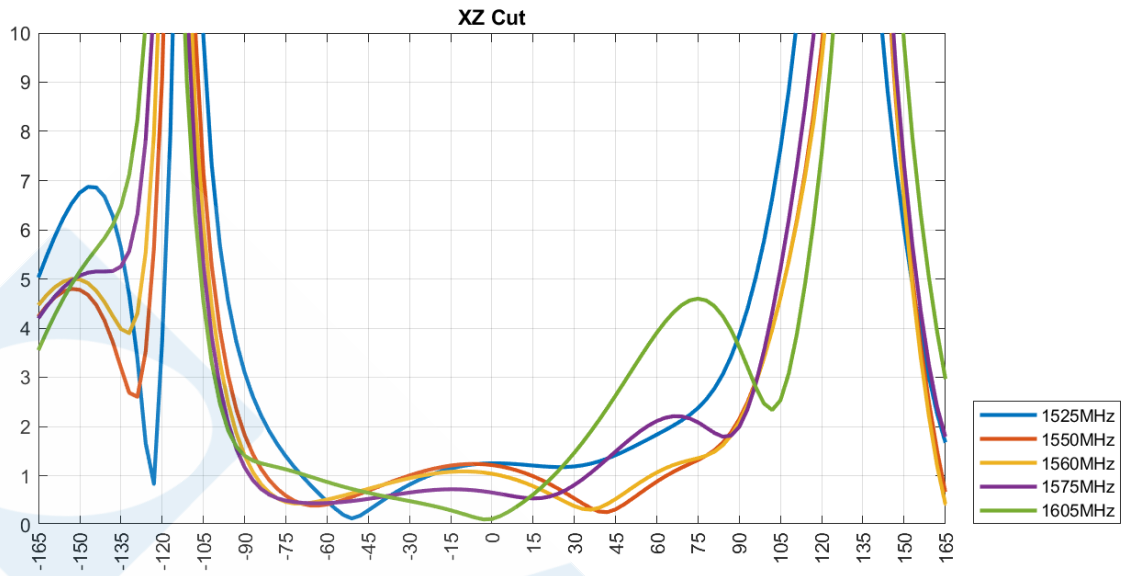

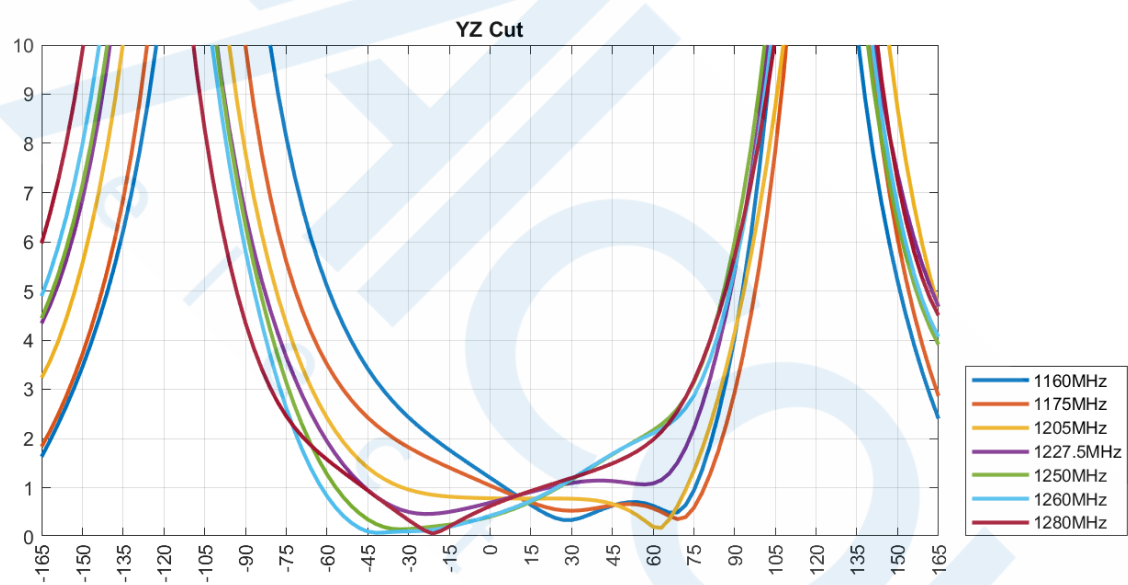
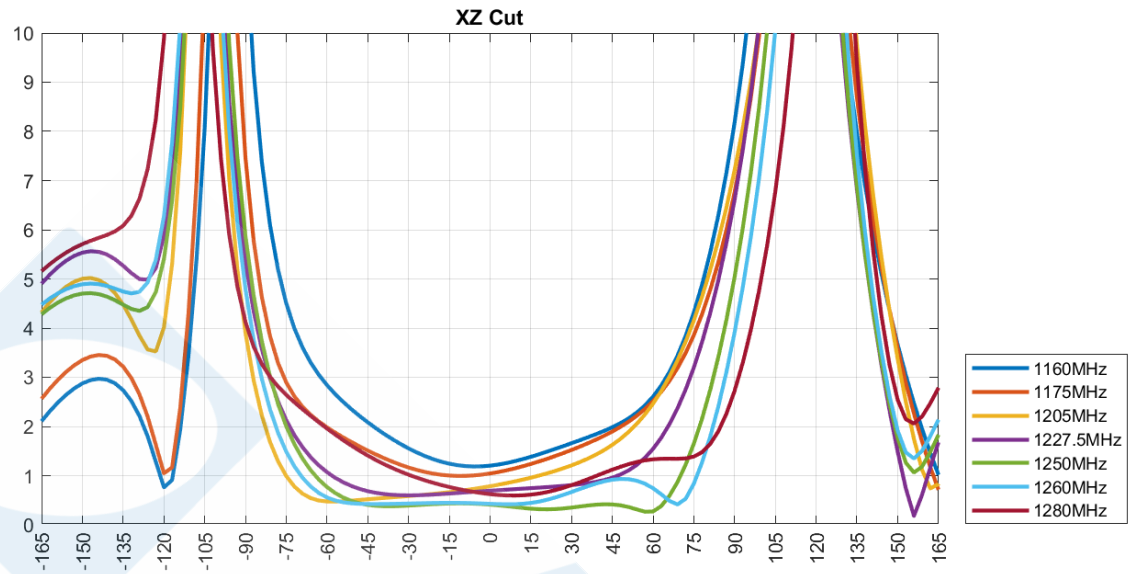

4. Radiation Patterns

4.1 Test Setup

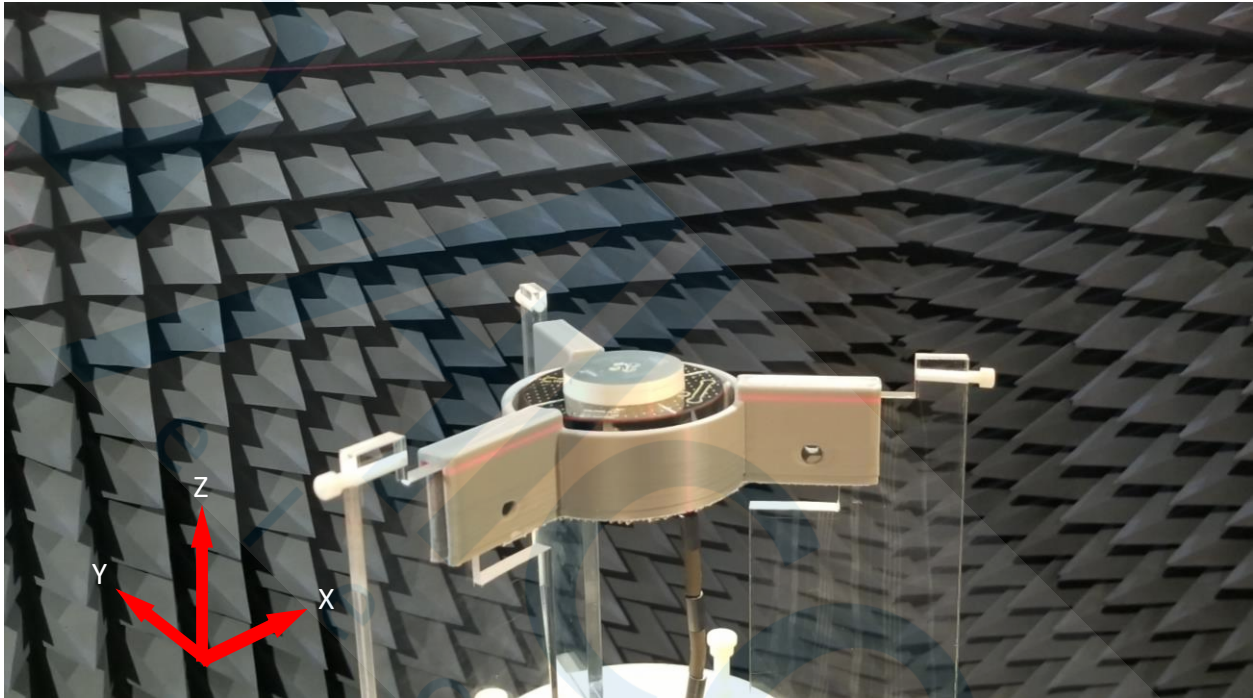

4.2 GNSS L1 Band 3D and 2D Radiation Patterns

Gain total, 1525MHz

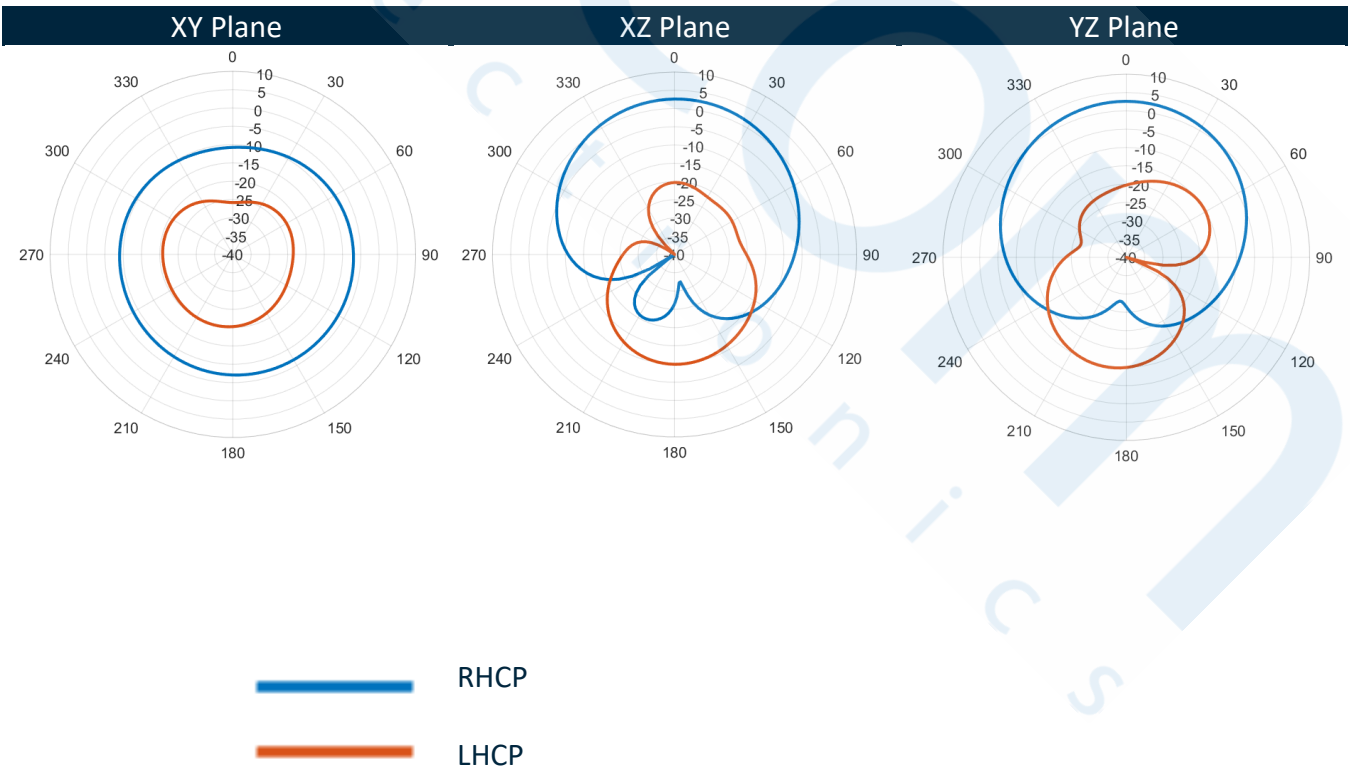
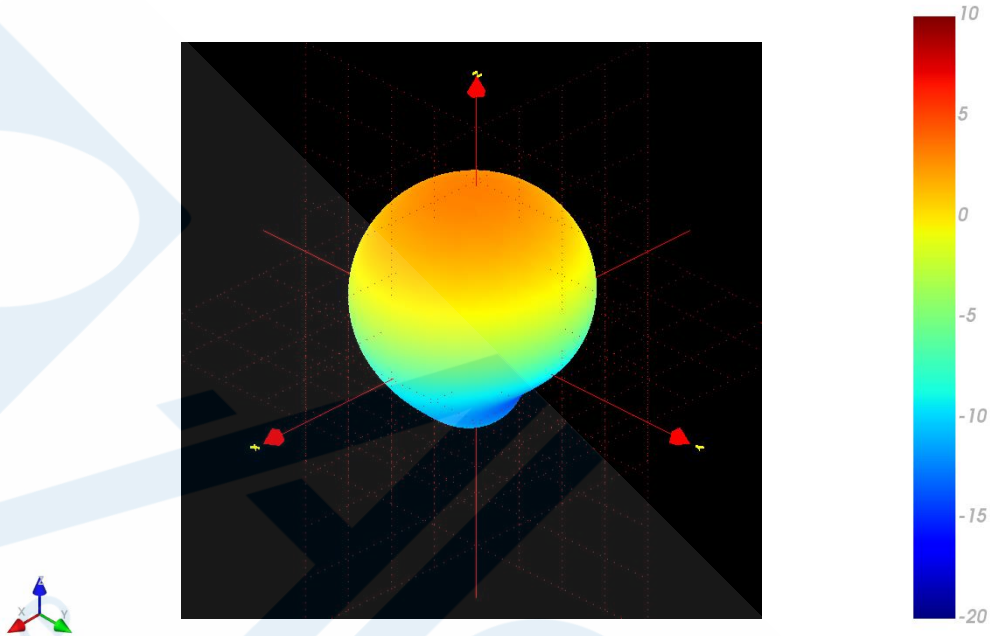

Gain total, 1561MHz

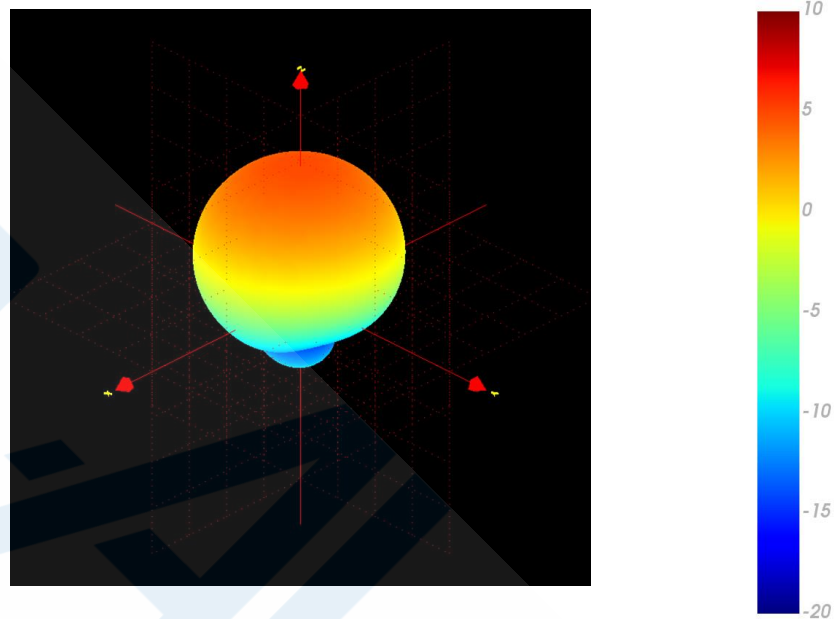

XY Plane XZ Plane YZ Plane

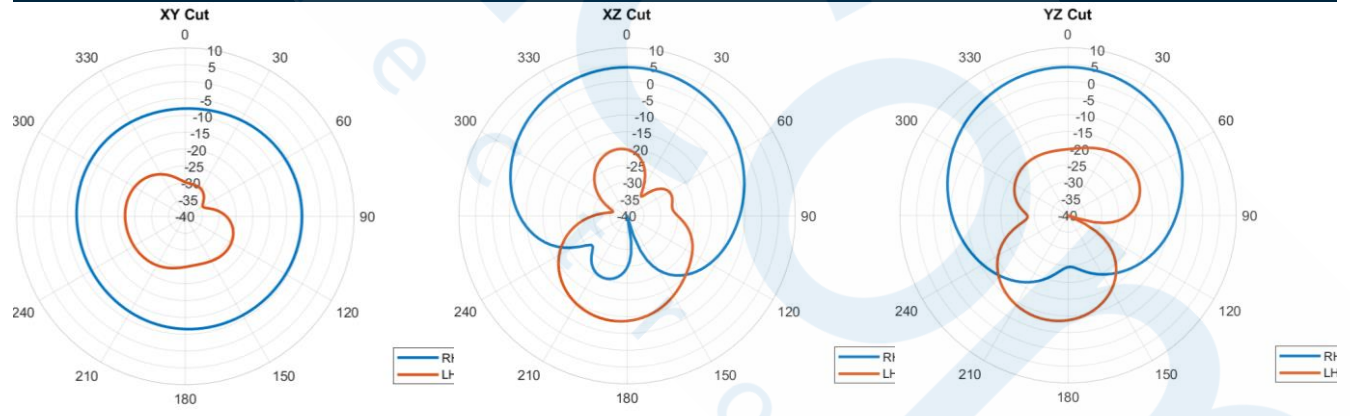

— RHCP
— LHCP

Gain total, 1575MHz

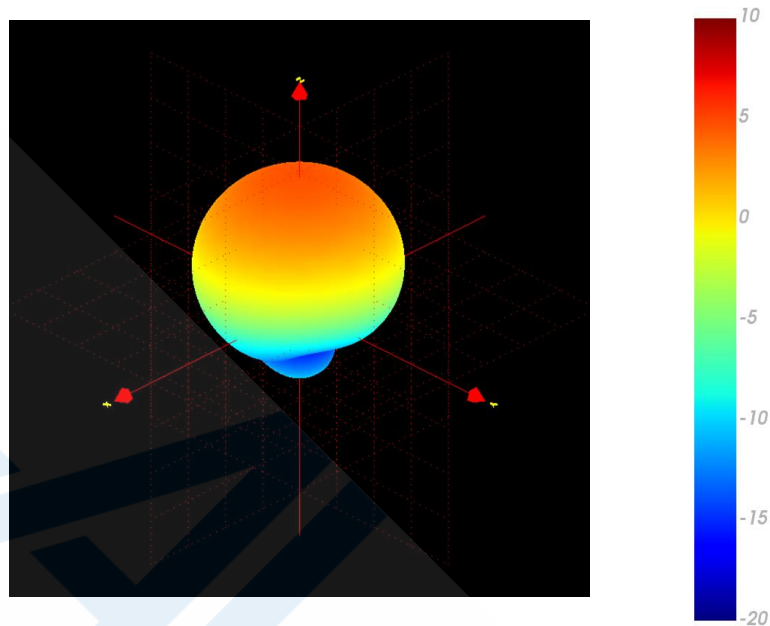

XY Plane

XZ Plane

YZ Plane

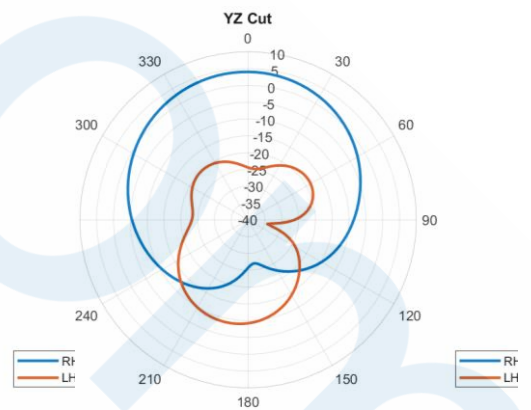
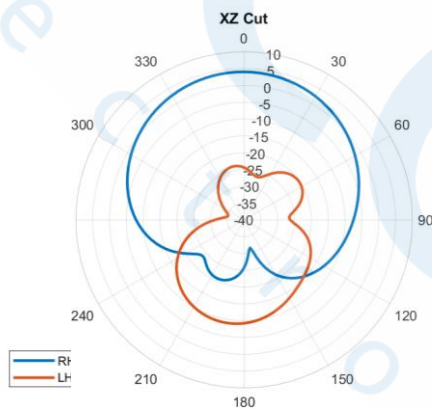
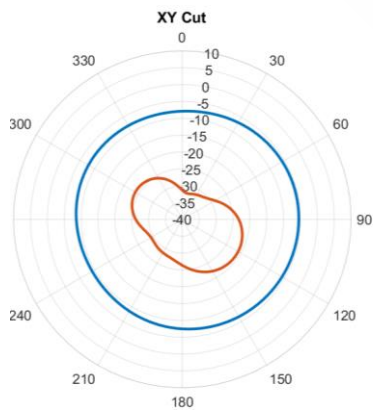

— RHCP
— LHCP

Gain total, 1605MHz

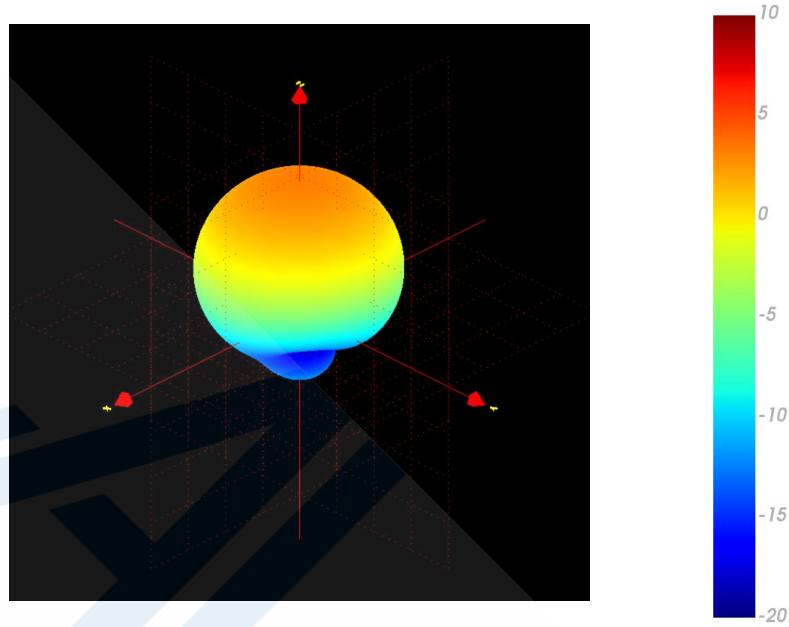

XY Plane

XZ Plane

YZ Plane

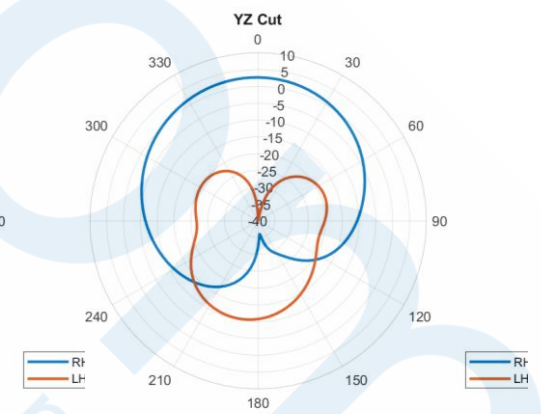
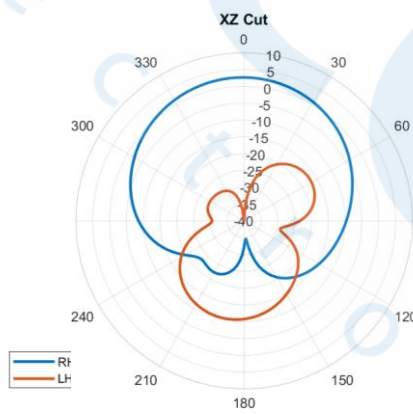
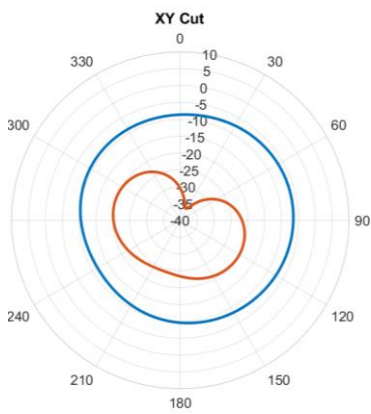

— RHCP
— LHCP

4.3 GNSS L2 L5 Band 3D and 2D Radiation Patterns

Gain total, 1175MHz

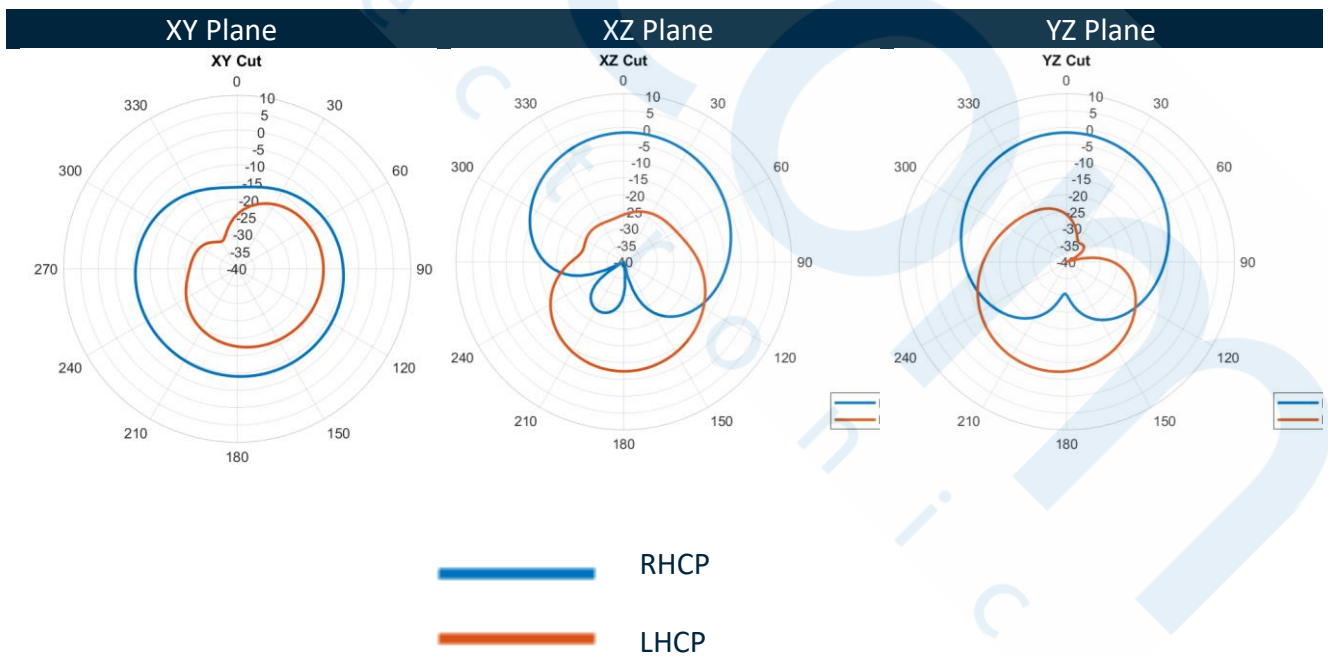
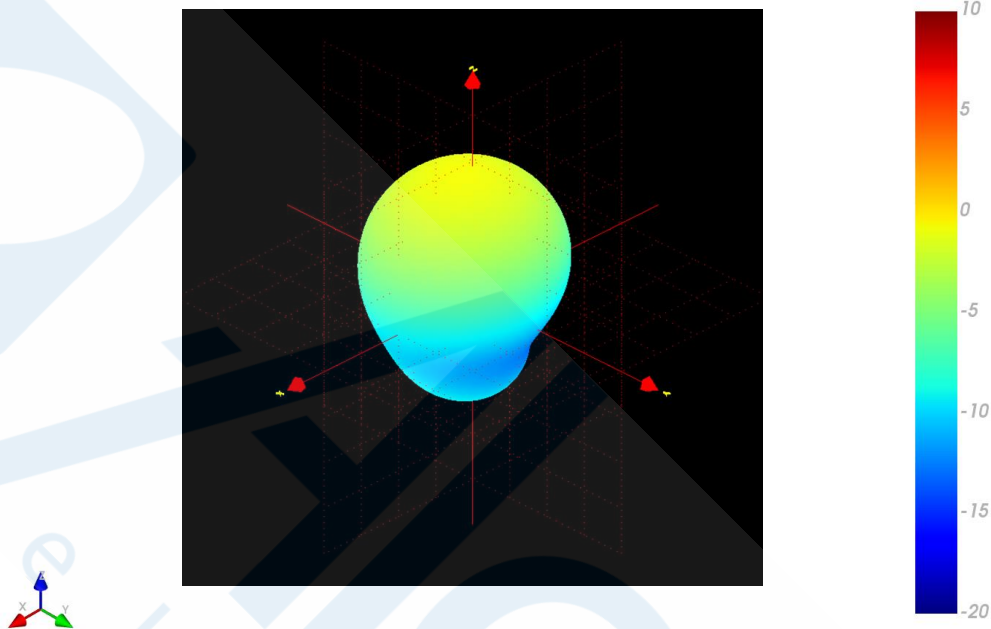

Gain total, 1227.5MHz

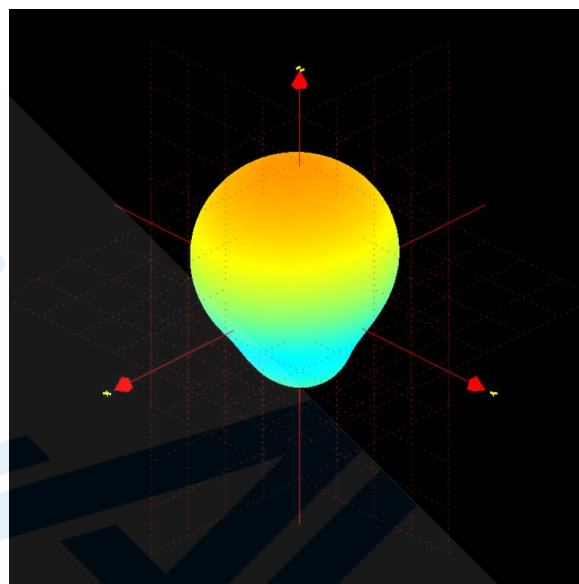

XY Plane XZ Plane YZ Plane

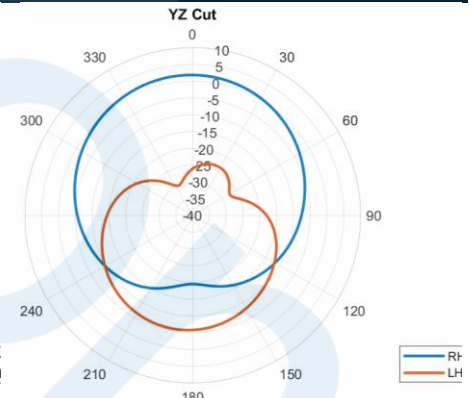
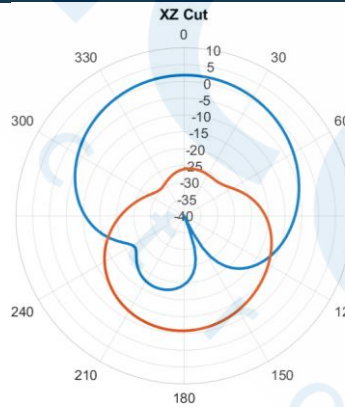
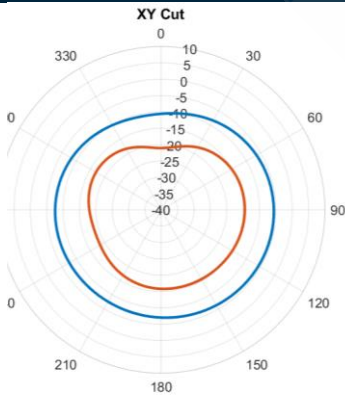

— RHCP
— LHCP

Gain total, 1280MHz

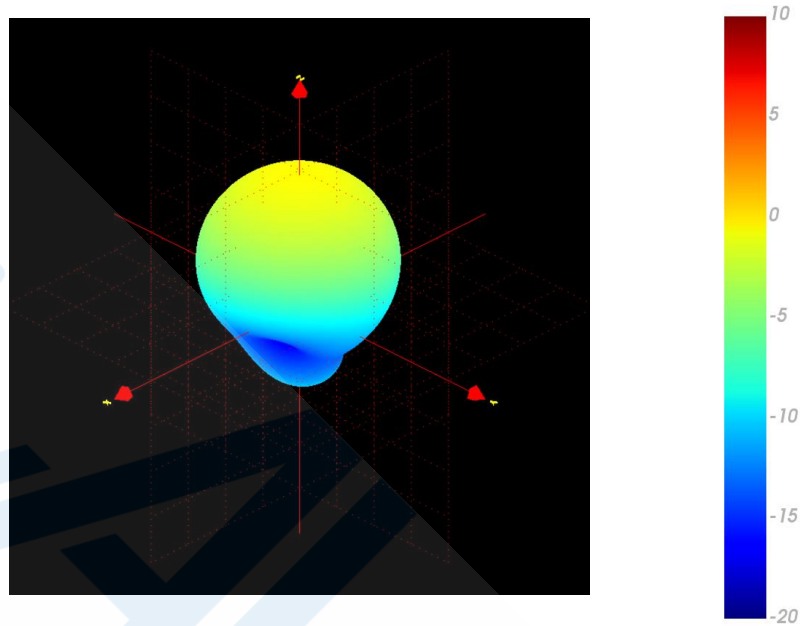

XY Plane XZ Plane YZ Plane

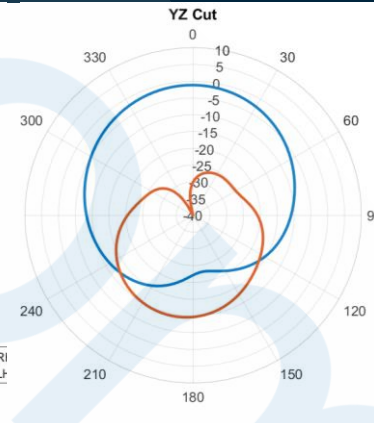
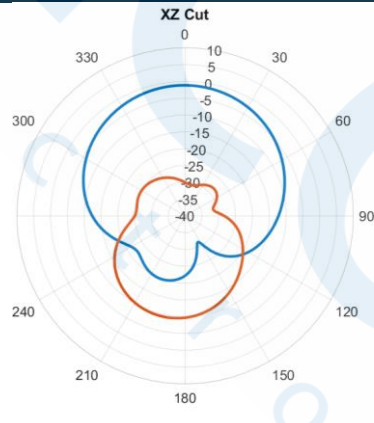
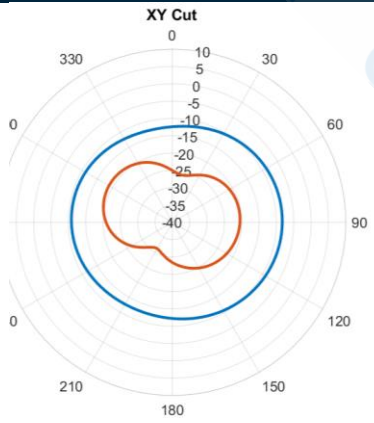

— RHCP
— LHCP

5. Mechanical Drawing (Units: mm)

ISO NO.: EDW-21-8-0469

STATE: Released

NOTES: 1. All material must be RoHS compliant.
 2. Remove the hex nut from antenna before attaching the active board.
 Reinstall the nut and torque to 4 in-lbs (45 N-cm) MAX. before soldering the pins.

REV	ZONE	DESCRIPTION	ENG	APPROVED	DATE
D01	All	Initial design	G. Samson	I. Mendez	10/25/2021

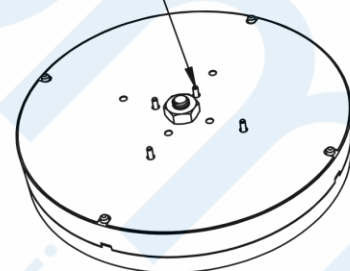
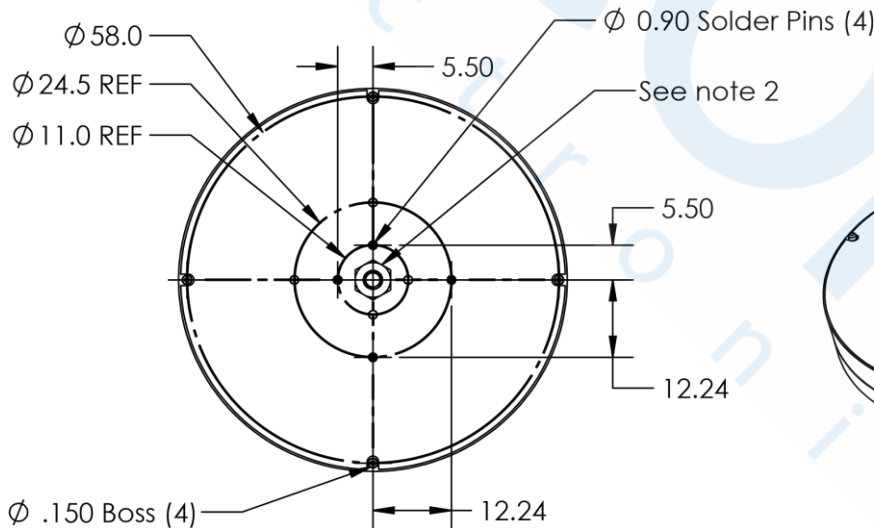
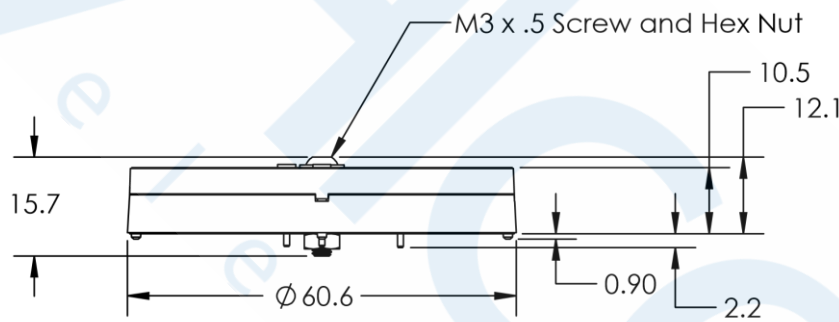
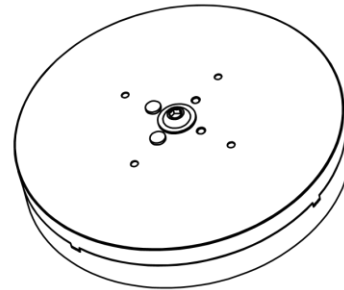
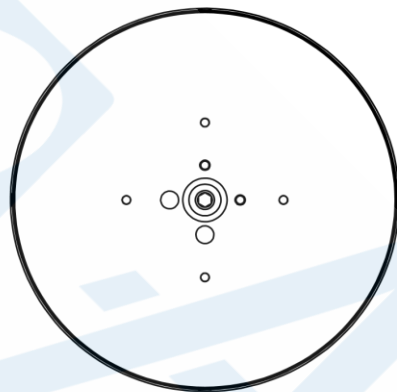

APPROVED BY: P. Frank	 <small>This drawing and its inherent design concepts are property of Taoglas. Not to be copied or given to third parties without the written consent of Taoglas.</small>
CHECK BY: I. Mendez	
DRAWN BY: G. Samson	
DATE: 10/25/2021	
<small>UNLESS OTHERWISE SPECIFIED TOLERANCES ON:</small> XX: ±0.5 X: ±0.3 X±0.2 XX±0.1 XXX±0.05	TITLE: Terrablast Multiband GNSS Stacked Patch Antenna Assembly PART NO.: GPDF6010.A
THIRD ANGLE PROJECTION	UNIT: mm SCALE: 1:2 PAGES: 1/1 REV: D01

6. Antenna Integration Guide

6.1 Antenna Integration

The antenna should be placed at the center of a circular ground plane (PCB with ground plane) with a diameter of 80mm or larger. A larger diameter will increase the gain. All data in this datasheet was taken with a 100mm-diameter PCB. Maintaining a circular, symmetric ground plane shape and symmetric environment around the antenna is critical to maintaining the excellent axial ratio and phase center performance shown in this datasheet. The opposite side of the PCB from the antenna may be used for device electronics and does not need to maintain symmetry.

To install the antenna to the PCB, remove the nut supplied with the antenna, place the antenna onto the PCB, and reinstall the nut to the torque specified in the mechanical drawing. Then solder the pins according to the recommendations in the Soldering Recommendations section.

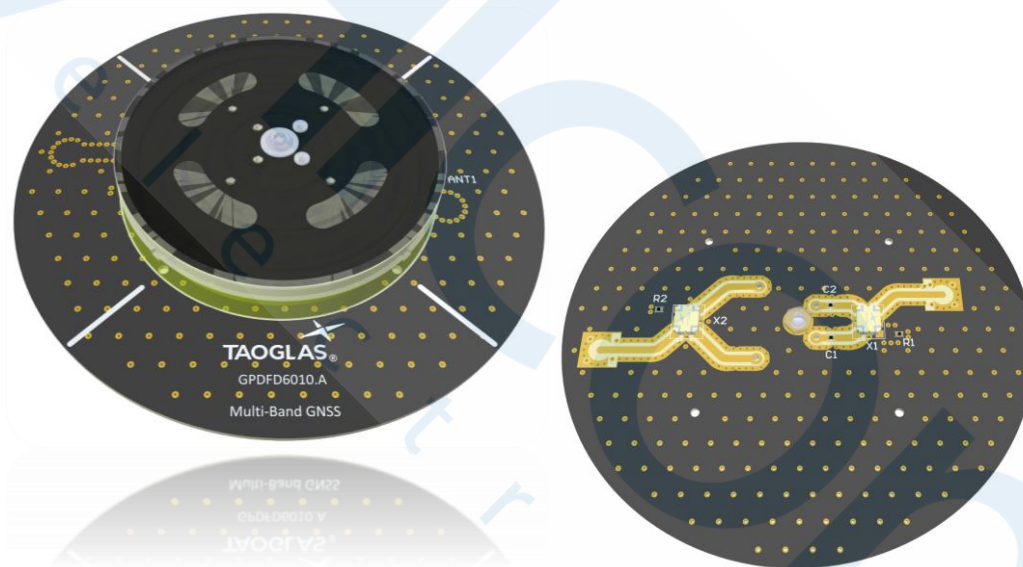

6.2 PCB Layout

The footprint and clearance on the PCB must comply with the antenna specification. The PCB layout shown in the diagram below demonstrates the antenna footprint.

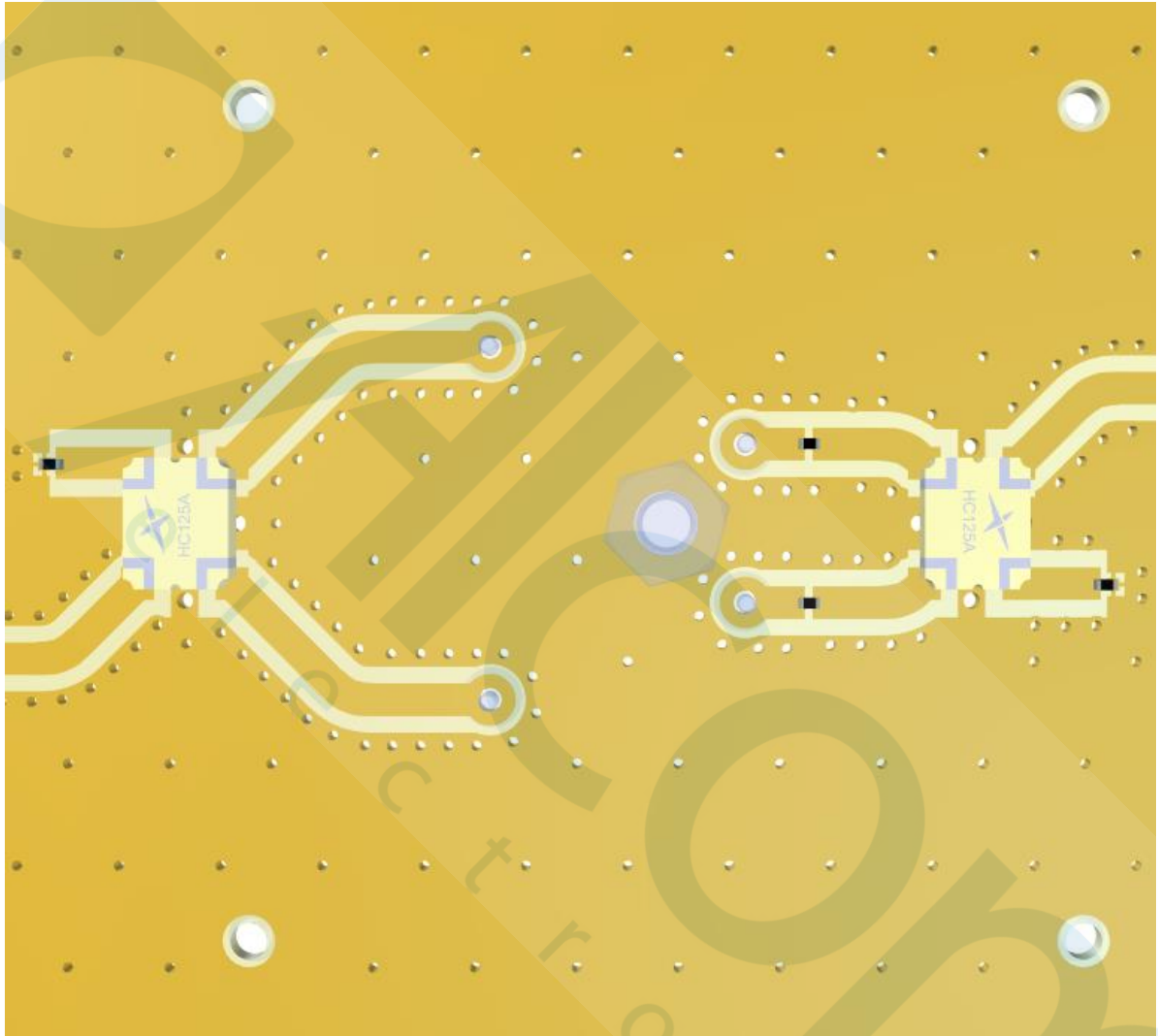

Bottom Side

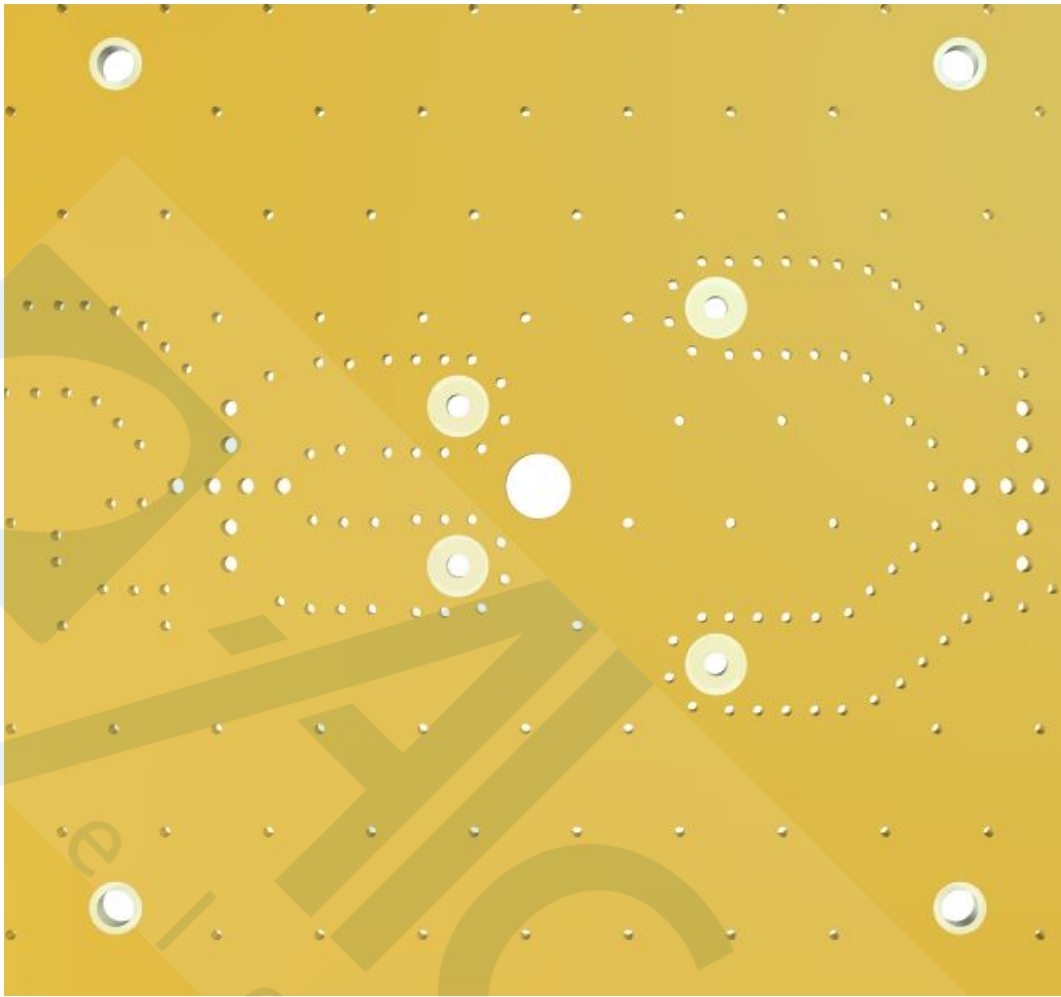

Top View

6.3 PCB Layout

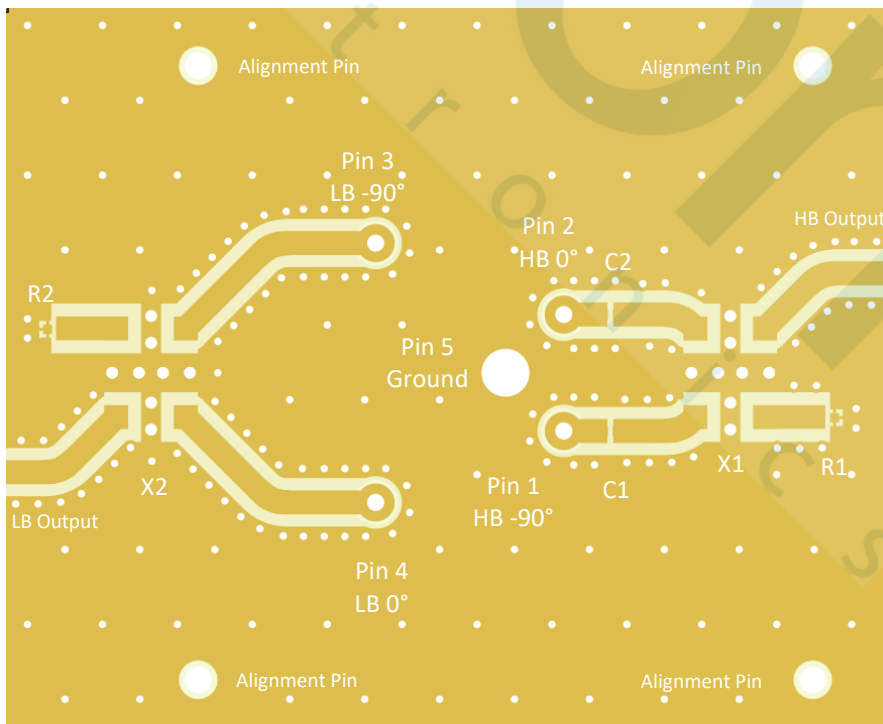

6.4 Schematic Symbol and Pin Definitions

The circuit symbol for the antenna is shown below. The antenna has 4 pins and 1 mounting/grounding screw as indicated below. The HB pins represent the higher GNSS frequency bands at 1525 - 1610MHz and the LB pins represent the lower GNSS frequency bands at 1164 - 1300MHz, including L5, L2, B3, E5, and E6 bands. The screw must be grounded to the PCB ground plane using the supplied nut (or a similar M3 nut).

Pin	Description
1	HB-1 (-90°)
2	HB-2 (0°)
3	LBP1 (-90°)
4	LBP2 (0°)
5	GND (Mounting & Ground)

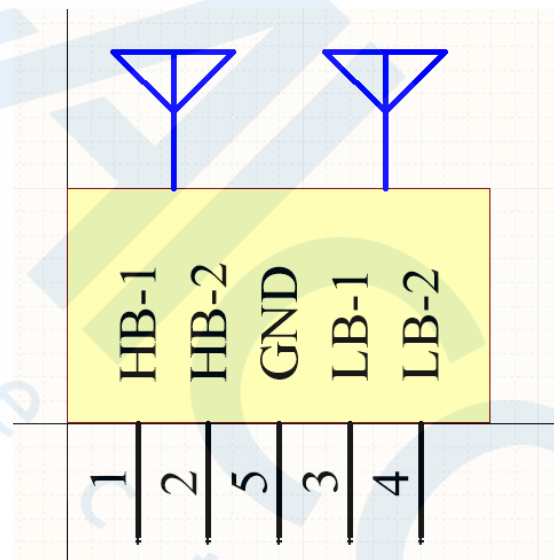

7. Evaluation Board Matching Circuit

Each patch element uses two orthogonal feeds that need to be combined in a hybrid coupler to ensure optimal axial ratio. Taoglas recommends our **HC125.A**, a high-performance hybrid coupler specifically engineered for use with our multi feed patches.

Two HC125.A's are required for this antenna, one for the high GNSS band of operation (1525-1610MHz) and another for the low GNSS band (1164MHz – 1300MHz). These hybrid couplers should be placed close to the antenna pins and terminated correctly using 2x 100-ohm resistors in parallel or a single 49.9 or 50-ohm resistor.

The high-band pins require a series capacitor for impedance matching. A 4.7pF high-Q capacitor is recommended, such as the Murata GJM1555C1H4R7BB01D.

The output of each of the hybrid couplers can feed into separate paths for high and low band GNSS filtering and amplification.

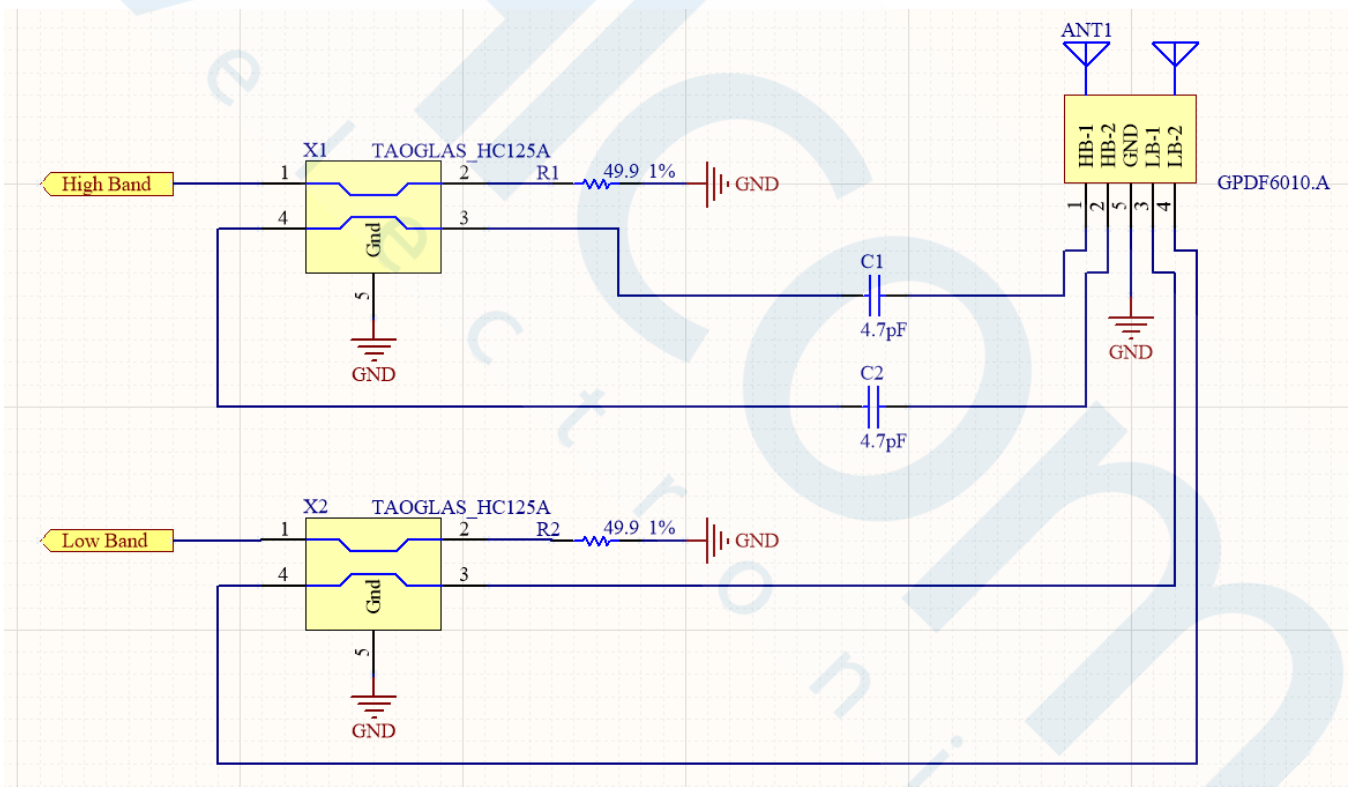

Matching Components

Designator	Type	Value	Description
R1, R2	Resistor (0402)	49.9Ω (1%)	Yageo RC0402FR-0749R9L
X1, X2	HC125.A Hybrid Coupler		Taoglas HC125.A
C1, C2	Capacitor (0402)	4.7pF (+/- 0.1pF)	Murata GJM1555C1H4R7BB01D
ANT1	Antenna		Taoglas GPDPF6010.A

8. Packaging

8.1 Automated Ferrochrome Soldering Machine

Soldering Temperature: 360-380°C

Soldering Duration: 3~4 seconds



8.2 Automated Ferrochrome Soldering Machine

Soldering Temperature: 360-380°C

Soldering Duration: 3~4 seconds

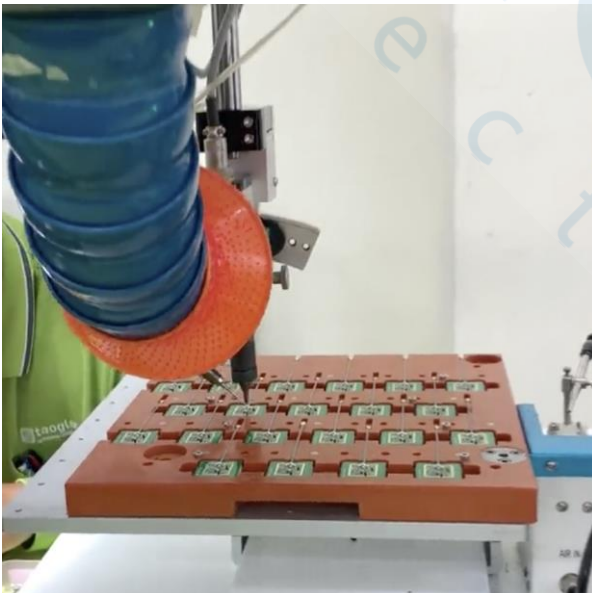

Please note that this process will require a one-time fixture to be made for each PCB design.

9. Packaging

24 pcs GPDF6010A
per PE Bag
Weight - 1100g

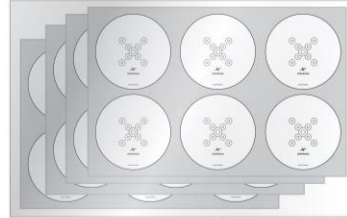

24 pcs GPDF6010A per Carton
Carton Dimensions - 263 x 154 x 96mm
Weight - 1200g

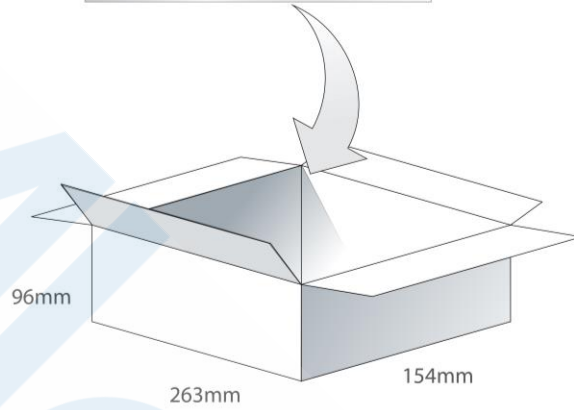

96 pcs GPDF6010A per Carton
Carton Dimensions - 327 x 280 x 218mm
Weight - 5Kg

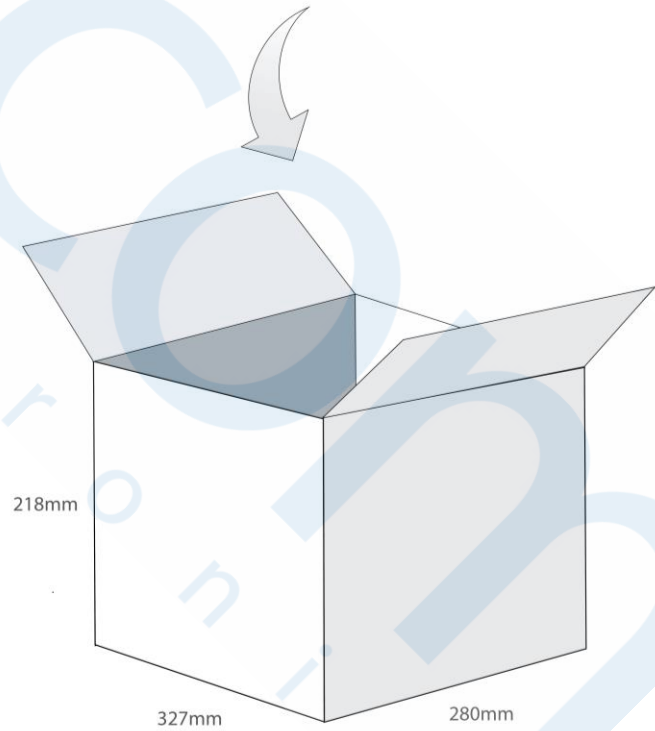

Changelog for the datasheet

SPE-21-8-111 – GPDF6010.A

Revision: A (Original First Release)

Date:	2020-10-14
Notes:	Initial Release
Author:	Jack Conroy

Previous Revisions



TAOGLAS®

www.taoglas.com



Singel 3 | B-2550 Kontich | Belgium | Tel. +32 (0)3 458 30 33
info@alcom.be | www.alcom.be

Rivium 1e straat 52 | 2909 LE Capelle aan den IJssel | The Netherlands
Tel. +31 (0)10 288 25 00 | info@alcom.nl | www.alcom.nl