

OSI Optoelectronics offers two distinct families of UV enhanced silicon photodiodes. Inversion channel series and planar diffused series. Both families of devices are especially designed for low noise detection in the UV region of electromagnetic spectrum.

Inversion layer structure UV enhanced photodiodes exhibit 100% internal quantum efficiency and are well suited for low intensity light measurements. They have high shunt resistance, low noise and high breakdown voltages. The response uniformity across the surface and quantum efficiency improves with 5 to 10 volts applied reverse bias. In photovoltaic mode (unbiased), the capacitance is higher than diffused devices but decreases rapidly with an applied reverse bias. Photocurrent non-linearity sets in at lower photocurrents for inversion layer devices compared to the diffused ones. Below 700nm, their responsivities vary little with temperature.

Planar diffused structure UV enhanced photodiodes show significant advantages over inversion layer devices, such as lower capacitance and higher response time. These devices exhibit linearity of photocurrent up to higher light input power compared to inversion layer devices. They have relatively lower responsivities and quantum efficiencies compared to inversion layer devices

There are two types of planar diffused UV enhanced photodiodes available: UVDQ and UVEQ. Both series have almost similar electro-optical characteristics, except in the UVEQ series, where the near IR responses of the devices are suppressed. This is especially desirable if blocking the near IR region of the spectrum is necessary. UVDQ devices peak at 970 nm and UVEQ devices at 720 nm (see graph). Both series may be biased for lower capacitance, faster response and wider dynamic range. Or they may be operated in the photovoltaic (unbiased) mode for applications requiring low drift with temperature variations. The UVEQ devices have a higher shunt resistance than their counterparts of UVDQ devices, but have a higher capacitance.

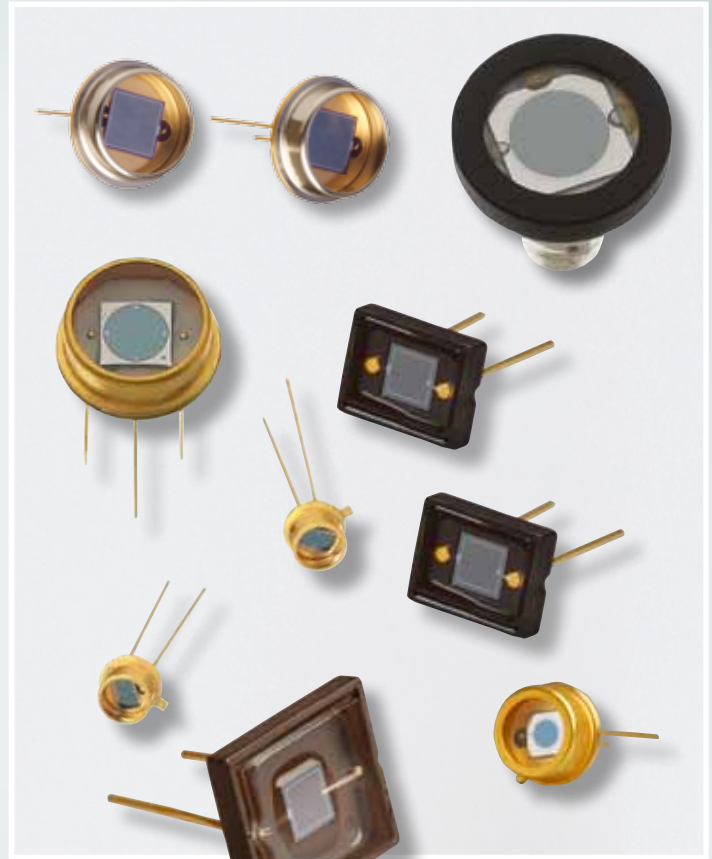

APPLICATIONS

- Pollution Monitoring
- Medical Instrumentation
- UV Exposure Meters
- Spectroscopy
- Water Purification
- Fluorescence

FEATURES

- Inversion series:
 - 100% Internal QE
- Ultra High R_{SH}
- Planar Diffused Series:
 - IR Suppressed
 - High Speed Response
 - High Stability
- Excellent UV response

These detectors are ideal for coupling to an OP-AMP in the current mode configuration as shown.

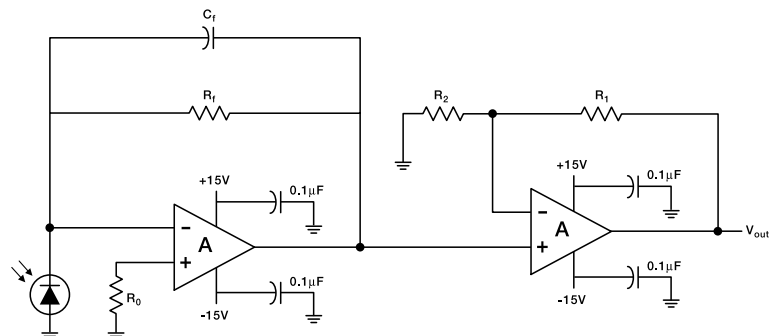

Planar Diffused UV Enhanced Photodiodes

Typical Electro-Optical Specifications at $T_A=23^\circ\text{C}$

Model Number	Active Area		Peak Wavelength λ_P (nm)	Responsivity (A/W)			Capacitance (pF)		Shunt Resistance (GOhm)		NEP (W/√Hz)		Reverse Voltage (V)	Rise Time (μs)		Temp.* Range (°C)		Package Style †
	Area (mm ²)	Dimensions (mm)		200 nm	633 nm	Peak	0 V		-10 mV		0V 200 nm			0 V 1kOhm	Operating	Storage		
				typ.	typ.	typ.	typ.	min.	typ.	typ.	max.	typ.						

'UV-DQ' Series Planar Diffused, Metal Package, Quartz Window

UV-005DQ	5.7	2.4 x 2.4	980	0.12	0.33	0.5	65	0.3	1	3.6 E-14	5	0.2	-20 ~ +60	-55 ~ +80	5 / TO-5
UV-013DQ	13	3.6 x 3.6					150	0.2	0.8	4.1 E-14		0.5			5 / TO-5
UV-035DQ	34	5.8 x 5.8					380	0.1	0.4	5.8 E-14		1			6 / TO-8
UV-100DQ	100	10 X 10					1100	0.04	0.2	8.2 E-14		3			11 /BNC

'UV-DQC' Series Planar Diffused, Ceramic Package, Quartz Window

UV-005DQC	5.7	2.4 x 2.4	980	0.12	0.33	0.5	65	0.3	1	3.6 E-14	5	0.2	-20 ~ +60	-20 ~ +80	25 / Ceramic
UV-035DQC	34	5.8 x 5.8					380	0.1	0.4	5.8 E-14		1			
UV-100DQC	100	10 X 10					1100	0.04	0.2	8.2 E-14		3			

'UV-EQ' Series Planar Diffused, Metal Package, Quartz Window

UV-005EQ	5.7	2.4 x 2.4	720	0.12	0.34	0.36	140	2	20	8.2 E-15	5	0.5	-20 ~ +60	-55 ~ +80	5 / TO-5
UV-013EQ	13	3.6 x 3.6					280	1	10	1.1 E-14		1			5 / TO-5
UV-035EQ	34	5.8 x 5.8					800	0.5	5	1.6 E-14		2			6 / TO-8
UV-100EQ	100	10 X 10					2500	0.2	2	2.6 E-14		7			11 /BNC

'UV-EQC' Series Planar Diffused, Ceramic Package, Quartz Window

UV-005EQC	5.7	2.4 x 2.4	720	0.12	0.34	0.36	140	2	20	8.2E-15	5	0.5	-20 ~ +60	-20 ~ +80	25 / Ceramic
UV-035EQC	34	5.8 x 5.8					800	0.5	5	1.6 E-14		2			
UV-100EQC	100	10 X 10					2500	0.2	2	2.6E-14		7			

† For mechanical specifications please refer to pages 61 thru 73.

* Non-Condensing temperature and Storage Range, Non-Condensing Environment.

Typ. Responsivity with Quartz Window ($T_A = 25^\circ\text{C}$)

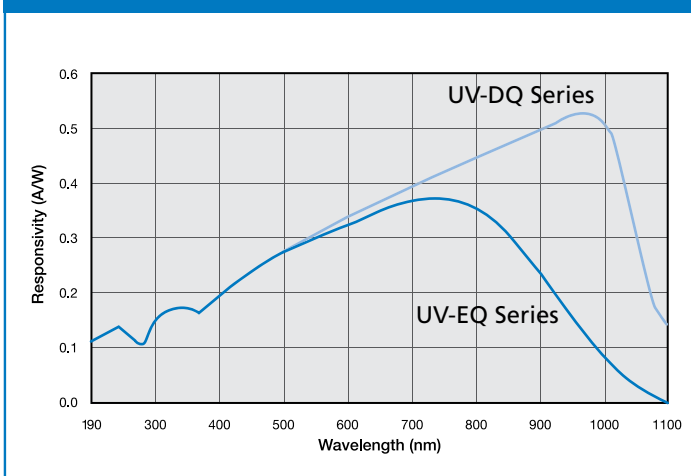

Typ. Capacitance vs. Reverse Bias ($T_A = 23^\circ\text{C}$, $f=1\text{MHz}$)

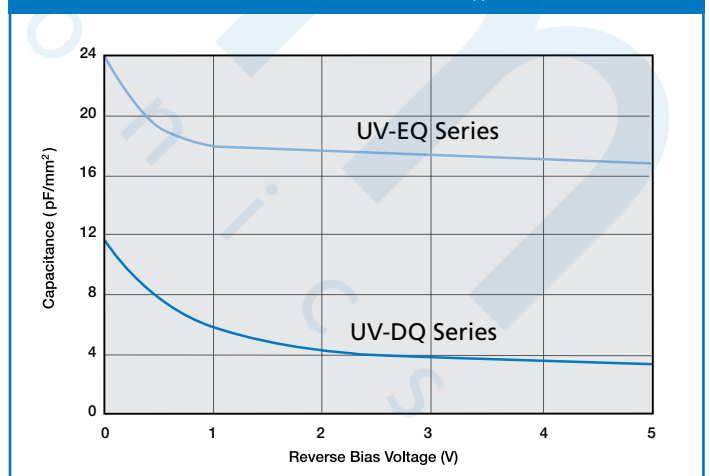

AVOID DIRECT LIGHT

Since the spectral response of silicon photodiode includes the visible light region, care must be taken to avoid photodiode exposure to high ambient light levels, particularly from tungsten sources or sunlight. During shipment from OSI Optoelectronics, your photodiodes are packaged in opaque, padded containers to avoid ambient light exposure and damage due to shock from dropping or jarring.

AVOID SHARP PHYSICAL SHOCK

Photodiodes can be rendered inoperable if dropped or sharply jarred. The wire bonds are delicate and can become separated from the photodiode's bonding pads when the detector is dropped or otherwise receives a sharp physical blow.

CLEAN WINDOWS WITH OPTICAL GRADE CLOTH / TISSUE

Most windows on OSI Optoelectronics photodiodes are either silicon or quartz. They should be cleaned with isopropyl alcohol and a soft (optical grade) pad.

OBSERVE STORAGE TEMPERATURES AND HUMIDITY LEVELS

Photodiode exposure to extreme high or low storage temperatures can affect the subsequent performance of a silicon photodiode. Storage temperature guidelines are presented in the photodiode performance specifications of this catalog. Please maintain a non-condensing environment for optimum performance and lifetime.

OBSERVE ELECTROSTATIC DISCHARGE (ESD) PRECAUTIONS

OSI Optoelectronics photodiodes, especially with IC devices (e.g. Photops) are considered ESD sensitive. The photodiodes are shipped in ESD protective packaging. When unpacking and using these products, anti-ESD precautions should be observed.

DO NOT EXPOSE PHOTODIODES TO HARSH CHEMICALS

Photodiode packages and/or operation may be impaired if exposed to CHLOROTHENE, THINNER, ACETONE, or TRICHLOROETHYLENE.

INSTALL WITH CARE

Most photodiodes in this catalog are provided with wire or pin leads for installation in circuit boards or sockets. Observe the soldering temperatures and conditions specified below:

Soldering Iron:	Soldering 30 W or less Temperature at tip of iron 300°C or lower.
Dip Soldering:	Bath Temperature: 260±5°C. Immersion Time: within 5 Sec. Soldering Time: within 3 Sec.
Vapor Phase Soldering:	DO NOT USE
Reflow Soldering:	DO NOT USE

Photodiodes in plastic packages should be given special care. Clear plastic packages are more sensitive to environmental stress than those of black plastic. Storing devices in high humidity can present problems when soldering. Since the rapid heating during soldering stresses the wire bonds and can cause wire to bonding pad separation, it is recommended that devices in plastic packages to be baked for 24 hours at 85°C.

The leads on the photodiode **SHOULD NOT BE FORMED**. If your application requires lead spacing modification, please contact OSI Optoelectronics Applications group at (310)978-0516 before forming a product's leads. Product warranties could be voided.



*Most of our standard catalog products are RoHS Compliant. Please contact us for details

Mechanical Drawings

Mechanical Specifications and Die Topography

1. Parameter Definitions:

A = Distance from top of chip to top of glass.

a = Photodiode Anode.

B = Distance from top of glass to bottom of case.

c = Photodiode Cathode

(Note: cathode is common to case in metal package products unless otherwise noted).

W = Window Diameter.

F.O.V. = Filed of View (see definition below).

2. Dimensions are in inches (1 inch = 25.4 mm).

3. Pin diameters are 0.018 ± 0.002 " unless otherwise specified.

4. Tolerances (unless otherwise noted)

General: $0.XX \pm 0.01$ "

$0.XXX \pm 0.005$ "

Chip Centering: ± 0.010 "

Dimension 'A': ± 0.015 "

5. Windows

All '**UV**' Enhanced products are provided with QUARTZ glass windows, 0.027 ± 0.002 " thick.

All '**XUV**' products are provided with removable windows.

All '**DLS**' PSD products are provided with A/R coated glass windows.

All '**FIL**' photoconductive and photovoltaic products are epoxy filled instead of glass windows.

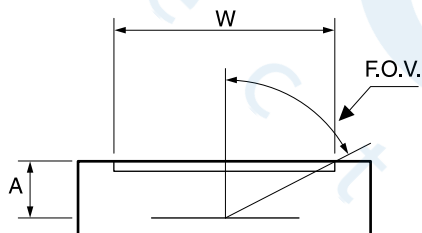

$$F.O.V. = \tan^{-1} \left(\frac{W}{2A} \right)$$

For Further Assistance
Please Call One of Our Experienced
Sales and Applications Engineers

310-978-0516

OSI Optoelectronics
An OSI Systems Company

- Or -

visit our website at

www.osioptoelectronics.com

Mechanical Specifications

All units in inches. Pinouts are bottom view.

1 TO-18		2 TO-5		3 TO-8																																		
<p>Products: PIN-020A PIN-040A PIN-040-DP/SB</p> <p>Pin Circle Dia.=0.100</p> <table border="1"> <thead> <tr> <th>P/N</th> <th>A</th> <th>B</th> <th>W</th> </tr> </thead> <tbody> <tr> <td>PIN-020A</td> <td>0.075</td> <td>0.200</td> <td>0.155</td> </tr> <tr> <td>PIN-040A</td> <td>0.075</td> <td>0.200</td> <td>0.155</td> </tr> </tbody> </table>		P/N	A	B	W	PIN-020A	0.075	0.200	0.155	PIN-040A	0.075	0.200	0.155	<p>Products: PIN-5DI PIN-5DPI PIN-13DI PIN-13DPI PIN-5-YAG CD-25T</p> <p>Pin Circle Dia.=0.200</p> <table border="1"> <thead> <tr> <th>P/N</th> <th>A</th> <th>B</th> <th>W</th> </tr> </thead> <tbody> <tr> <td>All Others</td> <td>0.094</td> <td>0.180</td> <td>0.240</td> </tr> <tr> <td>CD-25T</td> <td>0.050</td> <td>0.130</td> <td>0.23</td> </tr> </tbody> </table>		P/N	A	B	W	All Others	0.094	0.180	0.240	CD-25T	0.050	0.130	0.23	<p>Products: PIN-6DI PIN-6DPI PIN-44DI PIN-44DPI</p> <p>APD50-8-150-TO8</p> <p>Pin Circle Dia.=0.295</p> <table border="1"> <thead> <tr> <th>P/N</th> <th>A</th> </tr> </thead> <tbody> <tr> <td>PIN-6DI/6DPI APD50-8-150-TO8</td> <td>0.115</td> </tr> <tr> <td>PIN-44DI/44DPI</td> <td>0.125</td> </tr> <tr> <td>OSD35-0</td> <td>0.130</td> </tr> </tbody> </table>		P/N	A	PIN-6DI/6DPI APD50-8-150-TO8	0.115	PIN-44DI/44DPI	0.125	OSD35-0	0.130	
P/N	A	B	W																																			
PIN-020A	0.075	0.200	0.155																																			
PIN-040A	0.075	0.200	0.155																																			
P/N	A	B	W																																			
All Others	0.094	0.180	0.240																																			
CD-25T	0.050	0.130	0.23																																			
P/N	A																																					
PIN-6DI/6DPI APD50-8-150-TO8	0.115																																					
PIN-44DI/44DPI	0.125																																					
OSD35-0	0.130																																					
<p>Products: PIN-2DI PIN-2DPI PIN-3CDI PIN-3CDP PIN-3CDPI</p> <p>Pin Circle Dia.=0.100</p> <table border="1"> <thead> <tr> <th>A</th> <th>B</th> </tr> </thead> <tbody> <tr> <td>0.070</td> <td>0.200</td> </tr> <tr> <td>0.090</td> <td>0.150</td> </tr> </tbody> </table>		A	B	0.070	0.200	0.090	0.150	<p>Products: PIN-5D PIN-5DP PIN-5DP/SB PIN-13D PIN-13DP PIN-005E-550F UV-001 UV-005 UV-005DQ UV-005EQ UV-013DQ UV-013EQ UV-015 OSD-5-0 OSD15-0 OSD5-5T OSD15-5T</p> <p>Pin Circle Dia.=0.200</p> <table border="1"> <thead> <tr> <th>P/N</th> <th>A</th> <th>B</th> </tr> </thead> <tbody> <tr> <td>OSD-Prefix Devices</td> <td>0.050</td> <td>0.130</td> </tr> <tr> <td>UV-XXXDQ</td> <td>0.065</td> <td>0.138</td> </tr> <tr> <td>UV-XXXEQ</td> <td>0.055</td> <td>0.138</td> </tr> <tr> <td>All Others</td> <td>0.102</td> <td>0.180</td> </tr> </tbody> </table> <p>Quartz Window: OSD5.8-7Q UV Transmissive Window: OSD5.8-7U</p>		P/N	A	B	OSD-Prefix Devices	0.050	0.130	UV-XXXDQ	0.065	0.138	UV-XXXEQ	0.055	0.138	All Others	0.102	0.180	<p>Products: PIN-6D PIN-6DP PIN-44D PIN-44DP UV-020 UV-035DQ UV-035EQ UV-035</p> <p>Pin Circle Dia.=0.295</p> <table border="1"> <thead> <tr> <th>P/N</th> <th>A</th> <th>B</th> </tr> </thead> <tbody> <tr> <td>UV-035DQ</td> <td>0.130</td> <td>0.195</td> </tr> <tr> <td>UV-035EQ</td> <td>0.120</td> <td>0.195</td> </tr> <tr> <td>All Others</td> <td>0.140</td> <td>0.205</td> </tr> </tbody> </table>		P/N	A	B	UV-035DQ	0.130	0.195	UV-035EQ	0.120	0.195	All Others	0.140	0.205
A	B																																					
0.070	0.200																																					
0.090	0.150																																					
P/N	A	B																																				
OSD-Prefix Devices	0.050	0.130																																				
UV-XXXDQ	0.065	0.138																																				
UV-XXXEQ	0.055	0.138																																				
All Others	0.102	0.180																																				
P/N	A	B																																				
UV-035DQ	0.130	0.195																																				
UV-035EQ	0.120	0.195																																				
All Others	0.140	0.205																																				
<p>Products: PIN-3CD PIN-3CDP BPX-65 OSD1-0 OSD1-5T OSD3-5T OSD1-E OSD3-E</p> <p>Pin Circle Dia.=0.100</p> <table border="1"> <thead> <tr> <th>P/N</th> <th>A</th> <th>B</th> </tr> </thead> <tbody> <tr> <td>PIN-3CD / 3CDP</td> <td>0.087</td> <td>0.146</td> </tr> <tr> <td>BPX-65</td> <td>0.075</td> <td>0.200</td> </tr> <tr> <td>OSD-Prefix Devices</td> <td>0.080</td> <td>0.200</td> </tr> </tbody> </table> <p>Quartz Window: OSD1.2-7Q UV Transmissive Window: OSD1.2-7U</p>		P/N	A	B	PIN-3CD / 3CDP	0.087	0.146	BPX-65	0.075	0.200	OSD-Prefix Devices	0.080	0.200	<p>Products: PIN-125DPL</p> <p>Pin Circle Dia.=0.100</p>		<p>Products: PIN-HR005 PIN-HR008 PIN-HR020 PIN-HR026 PIN-HR040</p> <p>Pin Circle Dia.=0.100</p>																						
P/N	A	B																																				
PIN-3CD / 3CDP	0.087	0.146																																				
BPX-65	0.075	0.200																																				
OSD-Prefix Devices	0.080	0.200																																				

Mechanical Specifications

All units in inches. Pinouts are bottom view.

10 Low Profile

Products:

PIN-10DI
PIN-10DPI
PIN-10DPI/SB
UV-50L
UV-100L

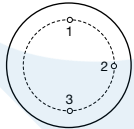
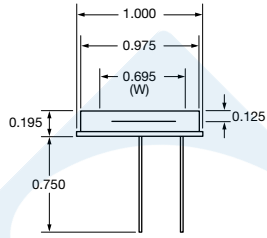

Pin Circle Dia.=0.73

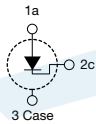

11 BNC

Products:

PIN-10D
PIN-10DP
PIN-10DP/SB
UV-50
UV-100
UV-100DQ
UV-100EQ

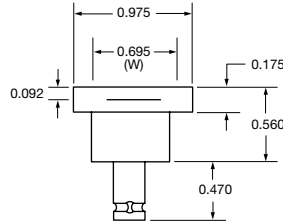

Outer Contact — Anode	PIN-10D, PIN-10DP, PIN-10DP/SB UV-100DQ, UV-100EQ
Outer Contact — Cathode	UV-50, UV-100

12 BNC

Products:

PIN-25D
PIN-25DP

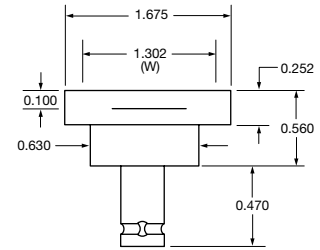

Outer Contact — Anode

13 Special BNC

Products:

PIN-10AP
PIN-10DF

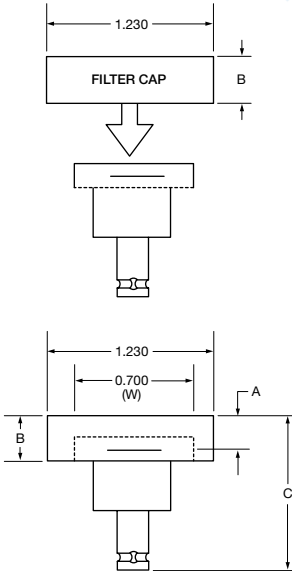

Dimensions			
P/N	A	B	C
PIN-10DF	0.217	0.330	1.020
PIN-10AP	0.386	0.550	1.415

14 TO-5

Products:

DLS-2S

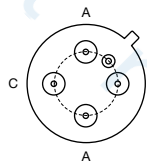
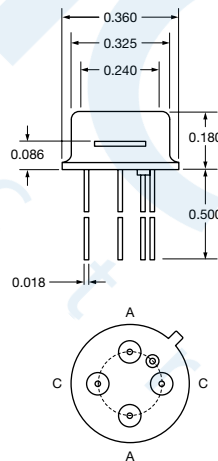

Pin Circle Dia.= 0.200
Bottom View

15 Special Plastic

Products:

FIL-UV50

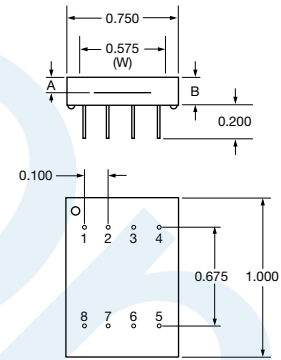

Dimensions

P/N	A	B
FIL-UV50	0.090	0.155

Pinouts

P/N	1	2	3	4	5	6	7	8
FIL-UV50	c	-	-	a	c	-	-	a

Mechanical Specifications

All units in inches. Pinouts are bottom view.

22 TO-5

Products:

XUV-005

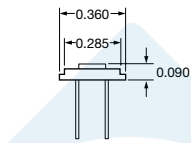

23 TO-8

Products:

XUV-020
XUV-035

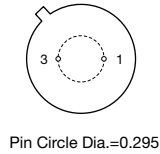
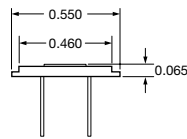

24 TO-8

Products:

PIN-DSIn-TEC

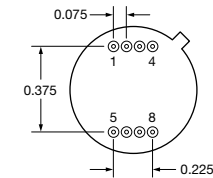
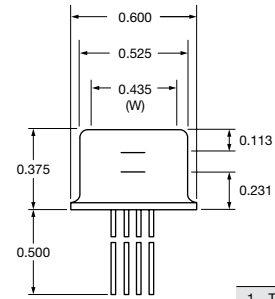

Pinout	
1	TEC (-)
2	Thermistor
3	Thermistor
4	TEC (+)
5	Top Silicon, Cathode
6	Top Silicon, Anode
7	Bottom InGaAs, Anode
8	Bottom InGaAs, Cathode

25 Special Ceramic / Plastic

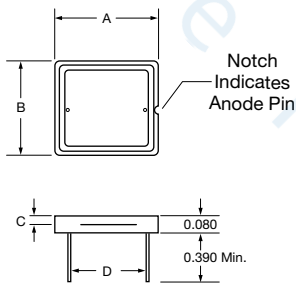

P/N	Dimensions			
	A	B	C	D
UV-005EQC	0.300	0.236	0.024	0.177
UV-035EQC	0.400	0.350	0.028	0.290
UV-100EQC	0.650	0.590	0.028	0.490
UV-005DQC	0.300	0.236	0.035	0.177
UV-035DQC	0.400	0.350	0.039	0.290
UV-100DQC	0.650	0.590	0.039	0.490
XUV-50C	0.650	0.590	0.027	0.490
XUV-100C	0.650	0.590	0.027	0.490
RD-100	0.650	0.590	0.027	0.490
RD-100A	0.650	0.590	0.027	0.490
UV-35P	0.390	0.345	0.050	0.275
OSD35-LR-A	0.390	0.350	---	0.290
OSD35-LR-D	0.390	0.350	---	0.290

Note: OSD35-prefix packages come with 0.31" (min.) leads

26 TO-8

Products:

RD-100
RD-100A
UV-35P
UV-005EQC
UV-035EQC
UV-100EQC
UV-005DQC
UV-035DQC
UV-100DQC
XUV-50C
XUV-100C
OSD35-LR-A
OSD35-LR-D

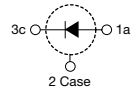
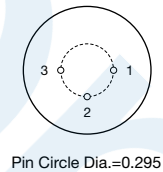
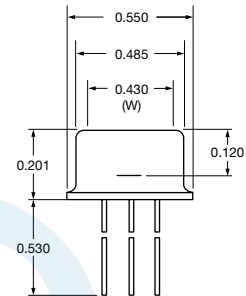

27 Special Plastic

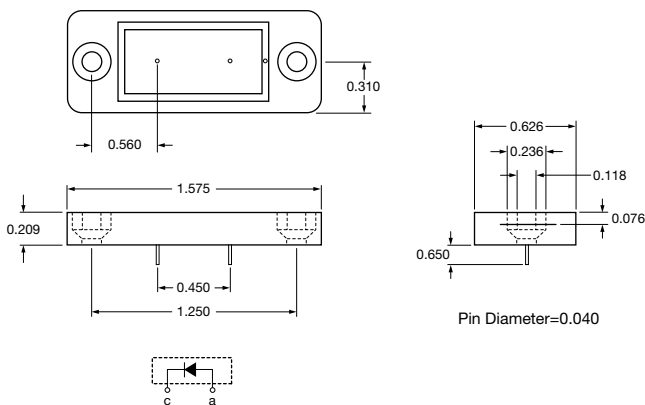

28 BNC

Products:

PIN-220D
PIN-220DP
PIN-220DP/SB

Products:

XUV-100

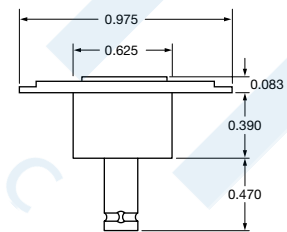

BNC Connector
Outer Contact = Cathode